



Delivering Excellence in

LABORATORY AND INDUSTRIAL FURNACES, OVENS & THERMAL ANALYSERS



- | Chamber Furnaces
- | Tube Furnaces
- | Ovens
- | Customized Furnaces & Ovens
- | Coal and Coke Testing Equipment
- | Thermal Analysers

Since its establishment in 1998, Elite Thermal has remained committed to delivering customer satisfaction through its core philosophy of providing high-quality products at competitive prices, complemented by exceptional customer service. This strategic approach has facilitated the development of strong brand recognition for Elite Thermal both in the UK and in international markets.

Throughout its history, Elite Thermal has built an extensive portfolio of both standard and bespoke electric furnaces and ovens, which are widely utilized in a diverse range of thermal process applications across the globe.

Supported by a core team with more than 50 years of expertise in furnace design, Elite Thermal possesses the expertise to offer innovative, tailored solutions that meet the ever-evolving demands of advanced materials research and development. The company also places significant value on establishing and nurturing long-term customer relationships, seeking to transform these connections into mutually beneficial partnerships.

Elite Thermal is fully dedicated to ensuring that its customers remain the central focus of its operations, with a steadfast commitment to addressing their needs and ensuring their success.

Yours Sincerely
Elite Team



Testimonials



Elite Thermal Systems have provided an excellent bespoke service with approachable, knowledgeable and responsive staff from initial sales enquiry stage through to design, manufacture, commissioning and after-sales care. You have listened and understood our unique and specific requirements and turned them into quality, reliable and competitively priced furnaces. "We would highly recommend Elite Thermal to other customers and have passed details to our technology partners and customers"

Stephen Kyle-Henney, Managing Director
TISICS, Aerospace Company in Farnborough, England



Elite Thermal Systems have been our go-to supplier for bespoke furnace equipment for over 15 years. Their staff are professional, knowledgeable and reliable and have built a range of equipment for us ranging from tube furnaces to multi-furnaces cyclic hot-corrosion rigs that are used to generate critical lifing data for the aerospace industry.

Dr. Simon Gray
Cranfield University, UK



Innovative solutions for your Applications

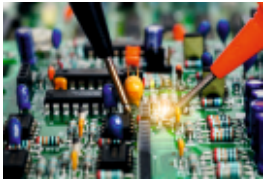

- | Aerospace
- | Automotive
- | Cement Industry
- | Ceramics
- | Coal Industry
- | Education
- | Electronics
- | Finishing Industry
- | Glass
- | Materials Testing
- | Metals Industry
- | Nuclear
- | Petrochemicals
- | Quality Assurance
- | Research
- | Superconductivity

	Model	Max Temp.	Capacity (Litres)	Page
Laboratory Ovens				7-8
High Temperature Ovens	BAF400, BAF500 & BAF600	400 to 600°C		7
Heavy Duty Ovens	—	200 to 600°C		7
Custom Designed Ovens				8
Chamber Furnaces				9-19
Air Re-circulating Furnaces	BAF7	750°C	15 to 45	9
Economy Chamber Furnaces	BCF11-VRP	1100°C	3 & 8	9
General Purpose Chamber Furnaces	BCF12-VRP	1200°C	3 to 45	10
General Purpose Chamber Furnaces	BCF13-VRP	1300°C	3 to 45	10
Rapid Heating Chamber Furnaces	BCFR12-VRP	1200°C	5 to 25	11
Rapid Heating Chamber Furnaces	BCFR13-VRP	1300°C	5 to 25	11
Laboratory Ashing Furnaces	BMF11-VRP	1100°C	3 & 7	12
Laboratory Ashing Furnaces	BSF12A	1200°C	4 to 45	13
Chamber Furnaces with Embedded Slab Heating elements	BSF12	1200°C	4 to 45	14
Top Loading Chamber Furnaces	TLCF	1200°C	5 to 125	14
Cupellation furnace	BRF12-CF24	1200°C	—	15
High Temperature Chamber Furnaces	BRF	1400°C to 1600°C	5 to 35	16
High Temperature Chamber Furnaces	BRF	1700°C and 1800°C	5 to 27	17
Bottom Loading Chamber Furnaces	BEB	1700°C and 1800°C	5	18
Light Industrial Chamber Furnaces	BIF	1200°C to 1700°C	72 to 227	19
Options & Accessories for Chamber Furnaces				20-21
Custom Designed Chamber Furnaces				22-24
	Model	Max Temp.	Hot Zones (mm)	Page
Tube Furnaces				25-32
Tube Furnaces Single Zone-Horizontal	TSH12	1200°C	250 to 940	27
Tube Furnaces Single Zone-Vertical	TSV12	1200°C	250 to 940	28
Tube Furnaces Single Zone-Horizontal	TSH14	1400°C	180 to 610	29
Tube Furnaces Single Zone-Horizontal	TSH15	1500°C	180 to 610	29
Tube Furnaces Single Zone-Horizontal	TSH16	1600°C	180 to 610	29
Tube Furnaces Single Zone-Vertical	TSV14	1400°C	180 to 610	30
Tube Furnaces Single Zone-Vertical	TSV15	1500°C	180 to 610	30
Tube Furnaces Single Zone-Vertical	TSV16	1600°C	180 to 610	30
Tube Furnaces Single Zone-Horizontal	TSH17	1700°C	300 to 600	31
Tube Furnaces Single Zone-Horizontal	TSH18	1800°C	300 to 600	31
Tube Furnaces Single Zone-Horizontal	TSH185	1850°C	300	31
Tube Furnaces Single Zone-Vertical	TSV17	1700°C	300 to 600	31
Tube Furnaces Single Zone-Vertical	TSV18	1850°C	300 to 600	31
Tube Furnaces Single Zone-Vertical	TSV175	1750°C	200 to 350	32

	Model	Max Temp.	Hot Zones (mm)	Page
Tube Furnaces				33-41
Split Tube Furnaces - Single Zone-Horizontal	TSHH11	1100°C	305 to 610	33
Split Tube Furnaces - Single Zone-Horizontal	TSHH12	1200°C	305 to 940	33
Split Tube Furnaces - Single Zone-Vertical	TSVH11	1100°C	305 to 610	34
Split Tube Furnaces - Single Zone-Vertical	TSVH12	1200°C	305 to 940	34
Split Tube Furnaces - Single Zone-Vertical	TSVH17	1700°C	250	34
Multi Zone Tube Furnaces-Horizontal	TMH12	1200°C	500 to 940	35
Multi Zone Tube Furnaces-Horizontal	TMH15	1500°C	450 to 610	35
Multi Zone Tube Furnaces-Horizontal	TMH16	1600°C	450 to 610	35
Multi Zone Tube Furnaces-Horizontal	TMH17	1700°C	450 to 610	35
Multi Zone Tube Furnaces-Horizontal	TMH18	1800°C	450 to 610	35
Multi Zone Tube Furnaces-Vertical	TMV12	1200°C	500 to 940	36
Multi Zone Tube Furnaces-Vertical	TMV15	1500°C	450 to 610	36
Multi Zone Tube Furnaces-Vertical	TMV16	1600°C	450 to 610	36
Multi Zone Tube Furnaces-Vertical	TMV17	1700°C	610	36
Multi Zone Tube Furnaces-Vertical	TMV18	1800°C	610	36
Vacuum Tube Furnaces - Single Zone	TSHvc12	1200°C	600	37
Vacuum Tube Furnaces - Single Zone	TSHvc15	1500°C	450	37
Multi Position Tube furnace	TSU	1200°C to 1600°C	—	38
Work Tubes				39
Insulation End Caps & Plugs, Radiation Shields/Screens				40
Triple Flange Gas Tight End Seals				41
Options & Accessories for Tube Furnaces				42-43
Custom Designed Tube Furnaces				44-45
Temperature Control Systems				46-48
Service, Maintenance, Upgrades & Repairs				49
Coal and Coke Testing Equipment				50-55
Minimum Free Space Oven, MFSU; MFSO-ISO; MFSO-ASTM				51
Volatile Matter Furnaces, VMF / ASTM				52
Volatile Matter Furnaces, VMF / ISO				53
Ashing Furnaces, BMF11 & BSF12/A				53
Free Swelling Index Furnace, FSI				54
Gray King Coke Test Furnace, GKF				55
Thermal Analysers				56-71
Thermogravimetric Analysers				57-64
Ash Fusion Determinators				65-70
Multi Tube/Pre Heat Furnace, TMTH14				71

Laboratory & Industrial Chamber Furnaces & Ovens up to 1800°C

Elite Thermal offers a wide range of standard and custom-designed chamber furnaces and ovens that are widely used in educational, research and industrial organisations throughout the world.

This design and engineering capability enables Elite Thermal and its representatives to service contracts ranging from laboratory scale through full-scale batch and continuous production equipment.

Elite Thermal offers a wide selection of chamber sizes in front loading, top loading, bottom loading, vacuum condition and numerous customizations for its chamber furnaces and oven products. These products are intended for usage in the temperature range of 80°C to 1800°C.

*Standard and Customized Chamber Furnaces & Ovens
for Research & Industrial Applications*

High Temperature Ovens (BAF)

The BAF series ovens are front-loading, high-temperature air recirculating ovens designed to the highest standards, with high-efficiency insulation in the doors and walls. Heavy-duty hinges, catches, and high-temperature seals are standard.

Standard Features:

- | Heating is by Mineral Insulated elements mounted in side air ducts outside of the oven chamber, aided by fan air recirculation.
- | The air is drawn from the rear of the chamber, passes over the heating elements to enter the chamber at the front.
- | The heated air then passes over the load and into the fan continuously recirculating the heated air for optimum thermal transfer and chamber temperature uniformity.
- | The external case is constructed from sheet steel finished in easy clean stove powder paint. The door and chamber are fitted with high temperature seals.
- | A small portion of the recirculating air is vented from the top of the chamber allowing any fumes to be directed into the customers extraction facility.



Model	BAF-400° C	BAF-500° C	BAF-600° C
Temperature Range	40°C 400°C	40° C 500°C	40°C 600°C
Chamber Interior	ST/ST	ST/ST	ST/ST
Electrical Supply	220/230V-1ph	220/230V-1ph	220/230V-1ph

Volume (Litres)	30	50	120
BAF-400	✓	✓	✓
BAF-500	✓	✓	✓
BAF-600	✓	✓	✓
BAF-400 (Fully welded stainless steel interior, without fan)	✓	✓	✓

Heavy Duty Ovens (200 to 600°C)

A comprehensive range of robust ovens is available in varying sizes up to 1000 litres capacity. Sizes above this can be designed to specific customer process requirements.



We also offer a Custom Design & Build Service for Specific Applications



400°C- Capacity 730 litres

- Designed for treating high power resistors



400°C- Capacity 27 litres per compartment

- Designed for curing of powder coated parts



400°C

- Oven with jigs for flow soldering of heat sink assemblies



600°C- Capacity 250 litres

- Designed for annealing thermionic valve glass envelopes



500°C- Capacity 610 litres

- Designed for treating thermionic valves glass envelopes



300°C & 600°C

- Dual oven rig-Designed for thermal performance testing on insulation materials - Sample size 300mm x 300mm



300°C

- Oven with variable speed rotating jig having capacity for 8 acid digestion vessels

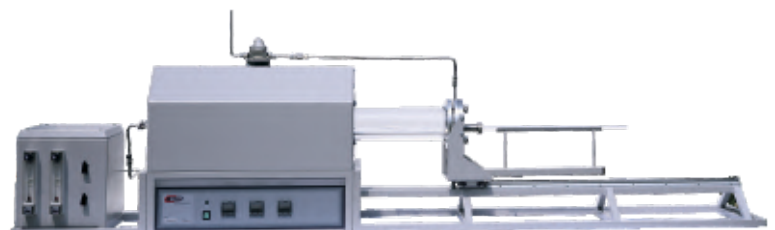

450°C - Capacity 75mm diameter x 500mm heated length

- 3 Zone tube oven with loading system for treatment of indium wafers

Air Re-circulating Furnaces

750°C Maximum

BAF 750°C - The BAF air re-circulating furnace provides good temperature uniformity and rapid thermal transfer to the load at lower temperatures.

Applications include annealing, stress relieving, tempering and normalising.

Standard Features:

- | Available in 15, 31 & 45 litre capacities as standard, with larger units made to customer specifications
- | MI heating elements, which are isolated from the liner
- | Stainless steel liner
- | The external case depth dimensions include the rear-mounted motor

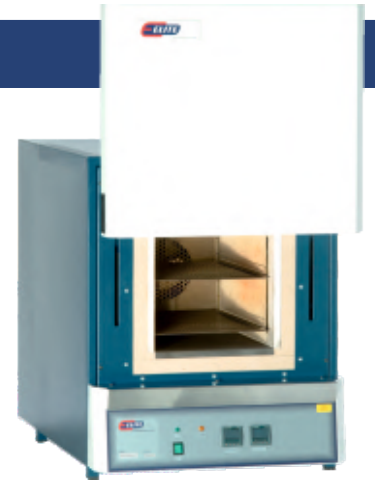

BAF7/15

Technical Data:

Model	Max Temp (°C)	Max Cont (°C)	Max Chamber Dims (mm) H x W x D	External Case Dims (mm) H x W x D	Chamber Capacity (Litres)	Nominal Power (Kw)	Volts	Phase	Net Wt. (kg)
BAF7/15	750	700	220 x 220 x 305	730 x 585 x 810	15	3.0	230V	1	88
BAF7/31	750	700	250 x 250 x 500	780 x 635 x 990	31	6.0	230V	1	130
BAF7/45	750	700	300 x 300 x 500	890 x 805 x 1020	45	6.0	230V	1	135

Economy Chamber Furnaces

1100°C Maximum

BCF11-VRP has been developed to meet the basic laboratory needs at economical prices

Standard Features:

- | BCF11 is suitable for light-duty general laboratory work and provides satisfactory performance for many heating applications
- | 5 & 8 litres are available chamber volumes
- | Vertically lifting door keeps the hot surface away from the user
- | A small ceramic chimney & hard ceramic hearth tile are fitted as standard
- | All furnace models are provided with Positive break door safety switch that isolates chamber from power supply when door is open
- | These furnaces are equipped with an Elite VRP controller, which includes 8 programs, each with 8 segments as standard. In addition, furnaces with Eurotherm controllers are also available. Other multi-segment, multi-program storage controllers are available as an option



BCF11/5-VRP

Options:

- | Over temperature protection controller

Technical Data:

Model	Max Temp (°C)	Max Cont (°C)	Max Chamber Dims (mm) H x W x D	External Case Dims (mm) H x W x D	Chamber Capacity (Litres)	Nominal Power (Kw)	Volts	Phase	Net Wt. (kg)
BCF11/5-VRP	1100	1050	150 x 150 x 225	593 x 400 x 505	5	2.0	230	1	36
BCF11/8-VRP	1100	1050	180 x 190 x 235	680 x 535 x 520	8	2.0	230	1	41

Custom Designed For all Chamber furnaces, Elite Thermal manufactures custom-built furnaces. Please contact us with your requirement .

weights and dimensions given are indicative only

General Purpose Chamber Furnaces

1200°C Maximum

BCF12-VRP has been developed for general purpose applications

Standard Features:

- | BCF12 is suitable for light-duty general laboratory work and provides satisfactory performance for many firing applications
- | 5, 8, 12, 25, 42 & 45 litre are available chamber volumes
- | A small ceramic chimney & hard ceramic hearth tile are fitted as standard
- | Vertically lifting door keeps the hot surface away from the user
- | Positive break door safety switch isolates chamber from power supply when door is open
- | These furnaces are equipped with an Elite VRP controller, which includes 8 programs, each with 8 segments as standard. In addition, furnaces with Eurotherm controllers are also available. Other multi-segment, multi-program storage controllers are available as an option



BCF12/8-VRP

Options:

- | Over temperature protection controller

Technical Data:

Model	Max Temp (°C)	Max Cont (°C)	Max Chamber Dims (mm) H x W x D	External Case Dims (mm) H x W x D	Chamber Capacity (Litres)	Nominal Power (Kw)	Volts	Phase	Net Wt. (kg)
BCF12/5-VRP	1200	1150	150 x 150 x 225	593 x 400 x 505	5	2.0	230	1	36
BCF12/8-VRP	1200	1150	180 x 190 x 235	680 x 535 x 520	8	2.0	230	1	41
BCF12/12-VRP	1200	1150	200 x 200 x 300	730 x 585 x 645	12	3.0	230	1	54
BCF12/25-VRP	1200	1150	250 x 250 x 400	780 x 635 x 695	25	6.0	230	1	67
BCF12/42-VRP	1200	1150	305 x 305 x 450	890 x 805 x 765	42	6.0	230	1	117
BCF12/45-VRP	1200	1150	300 x 300 x 500	890 x 805 x 765	45	6.0	230	1	120

General Purpose Chamber Furnaces

1300° C Maximum

BCF13-VRP is a fast heating furnace designed for general purpose use, where clean operating conditions prevail. Good temperature uniformity is achieved by the use of open heating elements retained in low thermal mass chamber wall panels.

Standard Features:

- | Vertically lifting door keeps the hot surface away from the user
- | Positive break door safety switch isolates chamber from power supply when door is open
- | A small ceramic chimney & hard ceramic hearth tile are fitted as standard
- | These furnaces are equipped with an Elite VRP controller, which includes 8 programs, each with 8 segments as standard. In addition, furnaces with Eurotherm controllers are also available. Other multi-segment, multi-program storage controllers are available as an option



BCF13/8-VRP

Options:

- | Over temperature protection controller

Technical Data:

Model	Max Temp (°C)	Max Cont (°C)	Max Chamber Dims (mm) H x W x D	External Case Dims (mm) H x W x D	Chamber Capacity (Litres)	Nominal Power (Kw)	Volts	Phase	Net Wt. (kg)
BCF13/5-VRP	1300	1250	150 x 150 x 225	593 x 400 x 505	5	2.0	230	1	36
BCF13/8-VRP	1300	1250	180 x 190 x 235	680 x 535 x 520	8	2.0	230	1	41
BCF13/12-VRP	1300	1250	200 x 200 x 300	730 x 585 x 645	12	3.0	230	1	54
BCF13/25-VRP	1300	1250	250 x 250 x 400	780 x 635 x 695	25	6.0	230	1	67
BCF13/42-VRP	1300	1250	305 x 305 x 450	890 x 805 x 765	42	6.0	400	3	117
BCF13/45-VRP	1300	1250	300 x 300 x 500	890 x 805 x 765	45	6.0	400	3	120

Rapid Heating Chamber Furnaces

1200°C Maximum

BCFR12-VRP has been developed for applications when rapid heating/cooling are required. This design is ideal for light/medium duty applications, but is not suitable for applications where the sample is large with a high mass.

Standard Features:

- | Available in 5, 15 & 25 litre capacities as standard, with larger units made to customer specifications
- | Heating is by free radiating wire elements located on 2 sides and roof of the chamber
- | A small ceramic chimney is fitted as standard
- | Vertically lifting door keeps the hot surface away from the user

| These furnaces are equipped with an Elite VRP controller, which includes 8 programs, each with 8 segments as standard. In addition, furnaces with Eurotherm controllers are also available. Other multi-segment, multi-program storage controllers are available as an option

| Rapid thermal response from free radiating coiled wire elements

Options:

- | Over temperature protection controller

Technical Data:

Model	Max Temp (°C)	Max Cont (°C)	Max Chamber Dims (mm) H x W x D	External Case Dims (mm) H x W x D	Chamber Capacity (Litres)	Nominal Power (Kw)	Volts	Phase	Net Wt. (kg)
BCFR12/5-VRP	1200	1100	150 x 150 x 150	680 x 535 x 520	5	2.75	230	1	45
BCFR12/15-VRP	1200	1100	230 x 230 x 300	730x 585 x 645	15	5.0	230	1	58
BCFR12/25-VRP	1200	1100	250 x 250 x 400	780 x 635 x 695	25	9.0	400	1	72



BCFR12/15-VRP

Rapid Heating Chamber Furnaces

1300°C Maximum

BCFR13-VRP has been developed for applications when rapid heating/cooling is required. This design is ideal for light/medium duty applications, but is not suitable for applications where the sample is large with a high mass.

Standard Features:

- | Available in 5, 15 & 25 litre capacities as standard, with larger units made to customer specifications
- | Heating is by free radiating wire elements located on 2 sides and roof of the chamber
- | A small ceramic chimney is fitted as standard
- | Vertically lifting door keeps the hot surface away from the user

| These furnaces are equipped with an Elite VRP controller, which includes 8 programs, each with 8 segments as standard. In addition, furnaces with Eurotherm controllers are also available. Other multi-segment, multi-program storage controllers are available as an option

| Rapid thermal response from free radiating coiled wire elements

Options:

- | Over temperature protection controller

Technical Data:

Model	Max Temp (°C)	Max Cont (°C)	Max Chamber Dims (mm) H x W x D	External Case Dims (mm) H x W x D	Chamber Capacity (Litres)	Nominal Power (Kw)	Volts	Phase	Net Wt. (kg)
BCFR13/5-VRP	1300	1200	150 x 150 x 150	680 x 535 x 520	5	2.75	230	1	45
BCFR13/15-VRP	1300	1200	230 x 230 x 300	730x 585 x 645	15	5.0	230	1	58
BCFR13/25-VRP	1300	1200	250 x 250 x 400	780 x 635 x 695	25	9.0	400	1	72



BCFR13/15-VRP

Product Quality All Elite Thermal Chamber Furnaces are designed and manufactured to meet the highest standards of Quality, Reliability and Operator Safety.

weights and dimensions given are indicative only

Pre-heated airflow feature in Elite Ashing Furnaces (BMF11 & BSF12/A)

For Ashing of samples, the furnace is designed with a pre-heated airflow system and a large chimney to ensure good combustion conditions within the chamber while facilitating adequate air exchange.

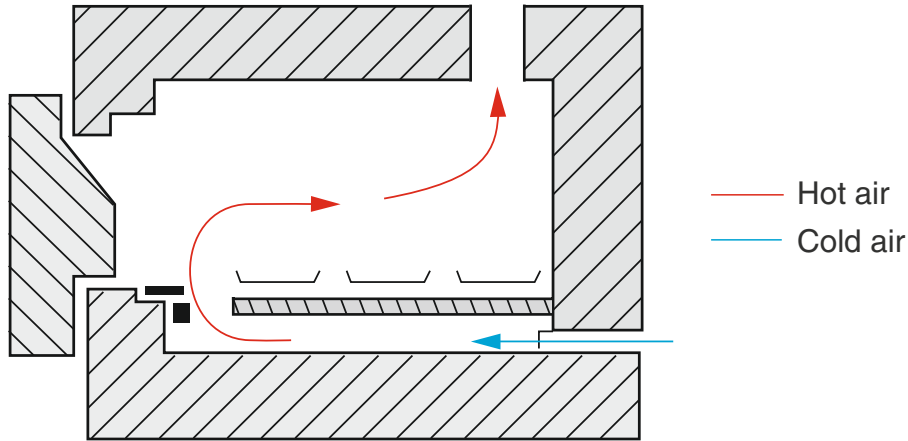

The chamber's airflow management system relies on natural convection to regulate air movement, promoting uniform temperature distribution. Hot air rises while cooler air descends, facilitated by a tall chimney that ensures effective circulation.

The system achieves 4-5 air volume changes per minute, maintaining steady airflow essential for consistent heat treatment. Incoming air is preheated to prevent localized cooling, particularly near the inlet, ensuring consistent temperature throughout the chamber. This stable airflow is crucial for ashing, where precise and uniform heating is required for accurate and repeatable results. The chamber is designed for high-precision applications needing reliable temperature control.

Laboratory Ashing Furnaces

1100°C Maximum

BMF11-VRP is designed for general purpose as well as ashing applications and features a pre-heated airflow system and large chimney to ensure good combustion conditions within the chamber

Standard Features:

- | 3 & 7 litre chamber volumes are available
- | Vertically lifting door keeps the hot surface away from the user
- | Positive break door safety switch that isolates chamber from power supply when door is open

Options:

- | Over temperature protection controller

| These furnaces are equipped with an Elite VRP controller, which includes 8 programs, each with 8 segments as standard. In addition, furnaces with Eurotherm controllers are also available. Other multi-segment, multi-program storage controllers are available as an option

| Its design makes it ideal for Ashing of Coal & coke samples

| A large metal chimney is fitted as standard



BMF11/3-VRP

Technical Data:

Model	Max Temp (°C)	Max Cont (°C)	Max Chamber Dims (mm) H x W x D	External Case Dims (mm) H x W x D	Chamber Capacity (Litres)	Nominal Power (Kw)	Volts	Phase	Net Wt. (kg)
BMF11/3-VRP	1100	1050	90 x 150 x 235	593 x 400 x 505	3	2.0	230	1	36
BMF11/7-VRP	1100	1050	130 x 180 x 310	680 x 535 x 520	7	3.0	230	1	39

Custom Designed For all Chamber furnaces, Elite Thermal manufactures custom-built furnaces. Please contact us with your requirement .

weights and dimensions given are indicative only

Laboratory Ashing Furnaces

1200°C Maximum

BSF12/A – The BSF12/A furnace is designed for ashing applications. Its design makes it ideal for treating heavier loads, and the processing of material that could contaminate floor mounted heating elements through spillage

Standard Features:

- | An ashing feature which provides combustion conditions within the chamber, and improved process fume removal from the chamber
- | Vertically lifting door keeps the hot surface away from the user
- | Positive break door safety switch isolates chamber from power supply when door is open
- | A large metal chimney is fitted as standard
- | BSF models use slabs with embedded heating elements
- | 2 sided heating
- | Replaceable ceramic hearth tile
- | Ideal for ashing foods, plastics, coal, coke & other hydrocarbon materials
- | This furnace comes with a controller having single ramp & set point and process timer



BSF12/6A

Options:

- | 4 side heating elements option is available for when heavier loads or metal retorts are fitted
- | Over temperature protection controller
- | Multi segment, multi program storage controllers

Technical Data:

Model	Max Temp (°C)	Max Cont (°C)	Max Chamber Dims (mm) H x W x D	External Case Dims (mm) H x W x D	Chamber Capacity (Litres)	Nominal Power (Kw)	Volts	Phase	Net Wt. (kg)
BSF12/4A	1200	1150	101 x 152 x 254	680 x 535 x 520	4	1.5	230	1	55
BSF12/6A	1200	1150	127 x 152 x 305	730 x 585 x 645	6	2.0	230	1	62
BSF12/10A	1200	1150	127 x 178 x 406	730 x 585 x 645	10	2.5	230	1	73
BSF12/15A	1200	1150	220 x 220 x 310	730 x 585 x 645	15	3.0	230	1	75
BSF12/22A	1200	1150	203 x 228 x 454	780 x 635 x 695	30	5.0	230	1	137
BSF12/45A	1200	1150	300 x 300 x 500	890 x 805 x 765	45	6.0	230	1	148

Product Quality All Elite Thermal Chamber Furnaces are designed and manufactured to meet the highest standards of Quality, Reliability and Operator Safety.

weights and dimensions given are indicative only

Chamber Furnaces with Slab Heating Elements

1200°C Maximum

BSF – The BSF furnace is designed for general laboratory use, its design makes it ideal for treating heavier loads, and the processing of material that could contaminate floor mounted heating elements through spillage

Standard Features:

- | Vertically lifting door keeps the hot surface away from the user
- | Positive break door safety switch isolates chamber from power supply when door is open
- | This furnace comes with a controller having single ramp & set point and process timer
- | BSF models use heating elements embedded in slabs
- | 2 sided heating
- | Replaceable ceramic hearth tile
- | A small ceramic chimney is fitted as standard

Options:

- | 4 side heating elements option is available for when heavier loads or metal retorts are fitted
- | Over temperature protection controller
- | Multi segment, multi program storage controllers



BSF12/6

Technical Data:

Model	Max Temp (°C)	Max Cont (°C)	Max Chamber Dims (mm) H x W x D	External Case Dims (mm) H x W x D	Chamber Capacity (Litres)	Nominal Power (Kw)	Volts	Phase	Net Wt. (kg)
BSF12/4	1200	1150	101 x 152 x 254	680 x 535 x 520	4	1.5	230	1	55
BSF12/6	1200	1150	127 x 152 x 305	730 x 585 x 645	6	2.0	230	1	62
BSF12/10	1200	1150	127 x 178 x 406	730 x 585 x 645	10	2.5	230	1	73
BSF12/15	1200	1150	220 x 220 x 310	730 x 585 x 645	15	3.0	230	1	75
BSF12/22	1200	1150	203 x 228 x 454	780 x 635 x 695	30	5.0	230	1	137
BSF12/45	1200	1150	300 x 300 x 500	890 x 805 x 765	45	6.0	230	1	148

Top Loading Chamber Furnaces

1200°C Maximum

TLCF – This is suited to applications which involves heavy loads, where samples are contained in tall crucibles, or where there is a danger of spillage onto the base of the chamber

Standard Features:

- | Relative ease and safety for the operator
- | These heating elements are robust cast refractory panels mounted on all sides
- | Exhaust port to assist fumes removal is fitted to the furnace door
- | A lever allows the operator to open and close top opening door safely and conveniently

Options:

- | Over temperature protection controller
- | Monitoring probes | Multi segment, multi program storage controllers



TLCF12/5

Technical Data:

Model	Max Temp (°C)	Max Cont (°C)	Max Chamber Dims (mm) H x W x D	External Case Dims (mm) H x W x D	Chamber Capacity (Litres)	Nominal Power (Kw)	Volts	Phase	Net Wt. (kg)
TLCF12/5	1200	1150	260 x 155 x 130	670 x 550 x 425	5	2.5	230	1	88
TLCF12/10	1200	1150	365 x 185 x 155	770 x 575 x 450	10	3.0	230	1	130
TLCF12/25	1200	1150	450 x 250 x 225	875 x 625 x 550	25	6.0	230	1	UR
TLCF12/125	1200	1150	620 x 450 x 450	1175 x 950 x 950	125	18.0	400	3	UR

Custom Designed For all Chamber furnaces, Elite Thermal manufactures custom-built furnaces. Please contact us with your requirement .

Cupellation furnace, BRF12-CF24

1200°C Maximum

BRF12-CF24 Cupellation furnaces are specifically designed for the fire assay process, a standard method used to determine the purity of precious metals.

The design of the cupellation furnace range safeguards it from corrosive environments that could cause a conventional furnace to deteriorate.

This Cupellation furnace accommodates 24 cupels of size No.8 or 32 cupels of size No.6. We also offer a bigger chamber furnace that can hold 47 cupels of size no.8 or 70 cupels of size no.6.

We also provide cupellation furnaces with other capacities upon request.

Standard Features:

- | Maximum Temperature: 1200°C
- | Maximum Continuous Temperature: 1200°C
- | Chamber (mm) - H x W x D -200 x 250 x 340. (Bigger chamber furnaces are also available and can be offered upon request)
- | Combination dense refractory for durability, load bearing and corrosion resistance with low thermal mass remainder for economical running
- | The working chamber is lined with silicon carbide slabs to withstand the lead fumes evolved during the process
- | A variable airflow system allows preheated air into the chamber and out of a large insulated chimney to evacuate process fumes as quickly as possible
- | R-type Thermocouples
- | Over Temperature protection is fitted as standard
- | A removable container attached to the chimney to collect condensed lead
- | Vertically lifting door keeps the hot surface away from the user
- | Positive break door safety switch isolates heating elements from power supply when door is opened
- | High-end micro-processor PID controller

Optional Features:

- | Multi segment, multi program storage controllers
- | Magnesia refractory cupels of various standard sizes



BRF12-CF24

Cupellation furnace capable of accommodating 47 cupels of size No.8 or 70 cupels of size No.6 is also available.

Cupellation furnace of other capacities are also available on request.

Product Quality All Elite Thermal Chamber Furnaces are designed and manufactured to meet the highest standards of Quality, Reliability and Operator Safety.

weights and dimensions given are indicative only

High Temperature Chamber Furnaces 1400°C, 1500°C and 1600°C Maximum

BRF – The BRF14, 15 & 16 models form a comprehensive range of high thermal efficiency, rapid heating chamber furnaces with operating temperatures up to 1400°C, 1500°C and 1600°C.

Standard Features:

- | The BRF14, BRF15 & BRF16 models are heated by silicon carbide rod elements
- | Silicon carbide heating elements provide long life and are able to withstand the stress of intermittent operation
- | Vertically lifting door keeps the hot surface away from the user
- | A door switch isolates power from the heating elements whenever door is opened for operator safety
- | A small ceramic chimney is fitted as standard

Options:

- | Electrically operated doors are available as chargeable option (E)
- | Multi segment, multi program storage controllers
- | Over temperature protection controller is optional



BRF15/5



BRF16/35 with electrically operated door option

Technical Data:

Model	Max Temp (°C)	Max Cont (°C)	Max Chamber Dims (mm) H x W x D	External Case Dims (mm) H x W x D	Chamber Capacity (Litres)	Nominal Power (Kw)	Volts	Phase	Net Wt. (kg)
BRF14/5	1400	1350	150 x 140 x 250	730 x 585 x 645	5	4.5	230	1	58
BRF14/10	1400	1350	190 x 180 x 310	780 x 635 x 715	10	7.5	230	1	74
BRF14/15	1400	1350	225 x 225 x 300	890 x 805 x 765	15	8.5	230	3	100
BRF14/27	1400	1350	290 x 270 x 340	890 x 805 x 765	27	12.0	400	3	110
BRF15/5	1500	1450	150 x 140 x 250	730 x 585 x 670	5	4.5	400	3	58
BRF15/10	1500	1450	190 x 180 x 310	780 x 635 x 715	10	7.5	400	3	74
BRF15/15	1500	1450	225 x 225 x 300	890 x 805 x 765	15	8.5	400	3	100
BRF15/27	1500	1450	290 x 270 x 340	890 x 805 x 765	27	12.0	400	3	110
BRF16/5	1600	1550	150 x 140 x 250	730 x 585 x 670	5	5.0	400	3	59
BRF16/10	1600	1550	190 x 180 x 310	780 x 635 x 715	10	10.0	400	3	74
BRF16/15	1600	1550	225 x 225 x 300	1050 x 950 x 823	15	11.0	400	3	100
BRF16/26	1600	1550	255 x 300 x 340	1050 x 950 x 823	26	14.0	400	3	110
BRF16/35	1600	1550	255 x 300 x 465	1475 x 1100 x 1000	35	16.0	400	3	380

Custom Designed For all Chamber furnaces, Elite Thermal manufactures custom-built furnaces. Please contact us with your requirement.

weights and dimensions given are indicative only

High Temperature Chamber Furnaces

1700°C and 1800°C Maximum

BRF – The BRF17 & 18 models form a comprehensive range of high thermal efficiency, rapid heating chamber furnaces with operating temperatures up to 1700°C and 1800°C.

Standard Features:

- | The BRF17 models are heated by Molybdenum Disilicide elements
- | The BRF18 models are heated by Molybdenum Tungsten Disilicide elements
- | Molybdenum Disilicide and Molybdenum Tungsten Disilicide provide long life and are the preferred heating elements for 1700°C and 1800°C
- | Over temperature protection is included in the standard specification for 1700 & 1800 models
- | Vertically lifting door keeps the hot surface away from the user
- | A door switch isolates power from the heating elements whenever door is opened for operator safety
- | A small ceramic chimney is fitted as standard



Options:

- | Multi segment, multi program storage controllers

Technical Data:

Model	Max Temp (°C)	Max Cont (°C)	Max Chamber Dims (mm) H x W x D	External Case Dims (mm) H x W x D	Chamber Capacity (Litres)	Nominal Power (Kw)	Volts	Phase	Net Wt. (kg)
BRF17/5M	1700	1650	160 x 150 x 215	635 x 900 x 695	5	4.4	230	1	128
BRF17/5E	1700	1650	160 x 150 x 215	635 x 900 x 695	5	4.4	230	1	128
BRF17/12M & E	1700	1650	230 x 230 x 230	1550 x 850 x 740	12	7.6	230	1	230
BRF17/27E	1700	1650	300 x 300 x 300	1600 x 880 x 800	27	12.0	400	3	316
BRF18/5M	1800	1750	170 x 150 x 200	635 x 900 x 785	5	4.7	230	1	170
BRF18/5E	1800	1750	170 x 150 x 200	635 x 900 x 785	5	4.7	230	1	170
BRF18/13M/E	1800	1750	220 x 200 x 300	1600 x 880 x 800	13	9.0	230	1	287
BRF18/18E	1800	1750	220 x 200 x 400	1600 x 880 x 800	18	11.6	230	1	365
BRF18/27E	1800	1750	300 x 300 x 300	1600 x 1050 x 880	27	15.0	400	3	494

M: Manually operated door option E: Electrically operated door option

Product Quality All Elite Thermal Chamber Furnaces are designed and manufactured to meet the highest standards of Quality, Reliability and Operator Safety.

weights and dimensions given are indicative only

Bottom Loading Chamber Furnaces 1700°C and 1800°C Maximum

BEB – The electrically operated elevator hearth facilitates smooth loading/unloading of the sample/crucible. The design provides a fast hearth ascent/descent, therefore making it ideal for rapid load transfer applications such as glass melting and firing of advanced ceramics. All instrumentation and control gear is housed in a separate free standing console.

Standard Features:

- | Rapid heating & cooling cycles can be achieved through raising and lowering the hearth
- | DC Motor with UP and DOWN controls. Upper and lower limit switches are fitted for safety
- | Elevator Travel is 400mm nominal with 8 seconds travel time
- | Molybdenum Disilicide / Molybdenum Tungsten Disilicide elements on all 4 sides of chamber for good uniform heating
- | Graded premium quality ceramic fibre insulation
- | High end Microprocessor PID controller
- | Overtemperature Protection System as standard
- | A small ceramic chimney is fitted as standard



BEB17 & 18

Options:

- | Compatible crucibles
- | Multi segment, multi program storage controllers
- | Flow meters for Air and inert gasses
- | Ceramic liners are available for use where corrosive fumes are generated or for use with protective atmospheres

Technical Data:

Model	Max Temp (°C)	Max Cont (°C)	Max Chamber Dims (mm) H x W x D	External Case Dims (mm) H x W x D	External Dimensions Controller (mm)	Chamber Capacity (Litres)	Nominal Power (Kw)	Volts	Phase	Net Wt. (kg)
BEB17/5	1700	1650	170 x 170 x 170	1125 x 800 x 763	610 x 530 x 602	5	5.0	230	1	188
BEB18/5	1800	1750	170 x 170 x 170	1125 x 800 x 763	610 x 530 x 602	5	6.0	230	1	188

Note: Other temperatures (1100°C to 1600°C) and chamber capacities/volumes are offered in custom-built models.

Custom Designed For all Chamber furnaces, Elite Thermal manufactures custom-built furnaces. Please contact us with your requirement.

weights and dimensions given are indicative only

Light Industrial Chamber Furnaces

1200°C Maximum

BIF – The BIF 12 furnaces are designed for general purpose industrial heat treatment applications which include stress-relieving normalising and annealing.

Elite Thermal offers a bespoke design service to tailor the BIF design to meet your specific process requirements.

A small ceramic chimney is fitted as standard

Options:

- Retorts and gas control systems are available for when processes involve inert or reducing atmospheres
- Independent monitoring probes
- Calibration/furnace surveys
- Over temperature protection controller
- Loading/unloading systems
- Multi segment, multi program storage controllers



BIF12/102

Technical Data:

Model	Max Temp (°C)	Max Cont (°C)	Max Chamber Dims (mm) H x W x D	External Case Dims (mm) H x W x D	Chamber Capacity (Litres)	Nominal Power (Kw)	Volts	Phase
BIF12/72	1200	1150	300 x 400 x 600	860 x 825 x 945	72	14	400	3
BIF12/102	1200	1150	350 x 450 x 650	1800 x 950 x 1150	102	20	400	3
BIF12/203	1200	1150	450 x 600 x 750	1950 x 1275 x 1225	203	35	400	3

Light Industrial Chamber Furnaces

1400°C to 1700°C Maximum

BIF – The BIF furnaces are designed for high temperature heat treatment applications for high temperature materials such as precious metals & technical ceramics.

- The applications include sintering of Engineering Ceramics, Metal Heat Treatments and Glass Melting and Processing.
- Elite Thermal offers a bespoke design service to tailor the BIF design to meet your specific process requirements.
- A small ceramic chimney & over temperature protection are fitted as standard.



BIF15/102

Technical Data:

Model	Max Temp (°C)	Max Cont (°C)	Max Chamber Dims (mm) H x W x D	External Case Dims (mm) H x W x D	Chamber Capacity (Litres)	Nominal Power (Kw)	Volts	Phase
BIF14/102	1400	1350	350 x 450 x 650	1800 x 950 x 1150	102	30	400	3
BIF14/203	1400	1350	450 x 600 x 750	1950 x 1275 x 1225	203	45	400	3
BIF15/102	1500	1450	350 x 450 x 650	1800 x 950 x 1150	102	30	400	3
BIF15/203	1500	1450	450 x 600 x 750	1950 x 1275 x 1225	203	45	400	3
BIF17/82	1700	1650	450 x 300 x 610	1830 x 1010 x 1000	82	24	400	3
BIF17/91	1700	1650	450 x 450 x 450	1960 x 1510 x 1125	91	24	400	3
BIF17/227	1700	1650	610 x 610 x 610	2150 x 1610 x 1200	227	36	400	3

Product Quality All Elite Thermal Chamber Furnaces are designed and manufactured to meet the highest standards of Quality, Reliability and Operator Safety.

weights and dimensions given are indicative only

Metal Atmosphere Retorts

- For use up to 1100°C when controlled atmosphere conditions are required and to protect the furnace insulation & heating elements from chemical attack (it may be necessary to update the furnace power when this option is selected)

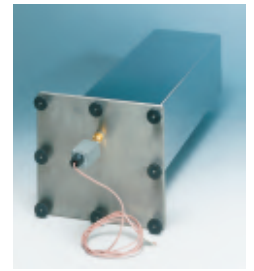

Hearth Tiles

- Hearth tiles provide protection for the furnace from spillage. Removable hearth tiles are offered at extra cost.
- They are available in variety of materials such as Silicon Carbide, Cordierite, Fibre Board, Alumina and Zirconia

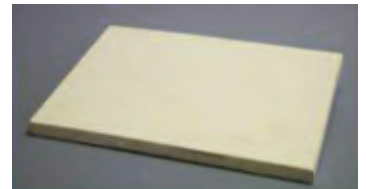

Ceramic Liners

- These are made of silicon carbide, alumina, and other ceramic materials, and are designed to protect heating elements from chemicals or fumes produced during sample analysis. These liners help maintain an inert environment during processes, ensuring minimal contamination. However, they are not completely gas-tight.



Solenoid valves

- An electric valve can be fitted to either start or stop a gas flow
- This can be activated manually by a panel mounted switch, but more typically it is controlled automatically through a program controller



Flammable Gas control/Safety system

- A full safety system for use with Hydrogen and other combustible gases is available providing timed purging and gas monitoring

Powered Exhaust/chimney

- A "Venturi – action" chimney system to improve the rate of fume/binder removal



Temperature Indicator

- An independent digital temperature indicator is built into the furnace control panel and wired to a panel mounted thermocouple socket. (for use with an independent monitor thermocouple)



Monitor thermocouple

- An independent thermocouple for use in conjunction with a digital temperature indicator

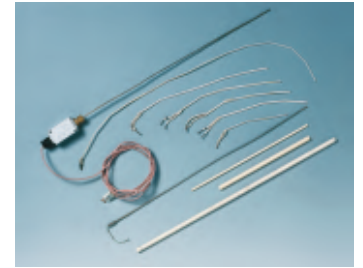

Digital communications

- Digital Communications ports can be fitted to furnaces for external programming or data logging from the temperature controller/programmer(s)
- Connections provided for single instrument RS232 or RS485 standards
- Multi instrument RS485 standard
- Ethernet connections available on certain temperature controllers

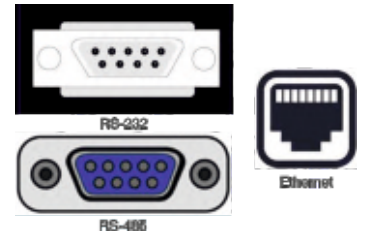

Digital communications Software

- We offer the i-Tools software package for communication between a computer and control instruments
- This software allows setting of instrument control parameters and time/temperature programs from a computer plus starting & stopping of programs and data logging from one or more controllers

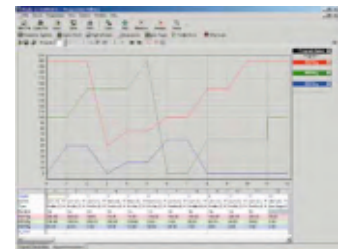

Chart recorders

- Various chart recorders can be supplied ranging from simple single pen with 100mm wide chart paper or multipoint paperless models



Time Switch

- A digital 7day / 24 hour time switch for programmed switch on / off when using basic temperature controllers. A time switch may not be necessary if more sophisticated controllers are fitted

Tiles and trays

- A broad range of shapes and sizes are available in various grades of ceramics and metals

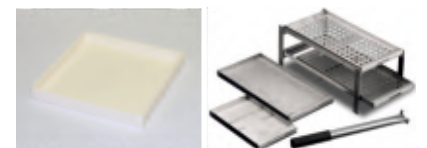

Crucibles, Boats, Ignition Dishes & Plates

- A wide variety of shapes and sizes are available in various grades of ceramics and metals





Retort Chamber Furnace

- Temperature: 1100°C
- Capacity: 32 litres
- Application: For treatments of magnetic steels



Double Furnaces Rig

- Temperature: 1200°C
- Application: For optoelectronics material research



2 Zone Precision Controlled Furnace

- Temperature: 1700°C
- Capacity: 122 litres
- Application: For R&D in precision ceramics



Multi Chamber Gradient Furnace

- Temperature: 1200°C
- Application: For Production of YBCO super conducting magnets



3 Zone Temperature Control Furnace

- Temperature: 1700°C
- Capacity: 72 litres
- Application: For processing ceramic fuel cell parts



Precision in ceramics

- Temperature: 1800°C
- Capacity: 11 litres
- Application: For precision in ceramics



Precious Metals Treatment

- Temperature: 1400°C
- Capacity: 350 litres
- Application: For heat treatment of Precious metals in protective atmosphere

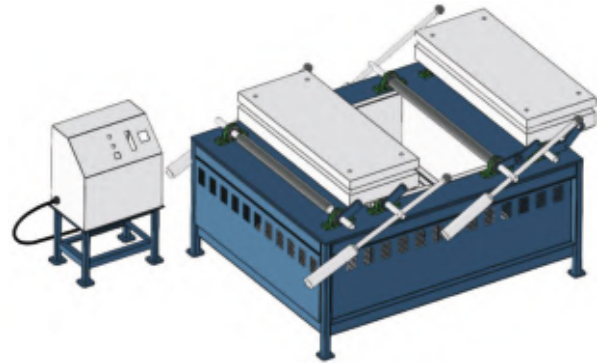

Top Loading Double Chamber Furnace

- Temperature: 1200°C
- Capacity: 144 litres
- Application: For Fusion applications



Miniature Furnace

- Temperature: 1800°C
- Application: For rapid sintering of tungsten electrodes



Special Elevator Retort Sintering Furnace

- Application: Sintering of specially lined "Heat Pipe" devices



General R & D Furnace

- Temperature: 1800°C
- Capacity: 27 litres
- Application: For general R&D work on ceramics & cements



Ceramic Electronic Components Processing

- Temperature: 1600°C
- Capacity: 122 litres
- Application: For processing ceramic electronic components



Retort Furnaces

- Temperature: 1000°C
- Capacity: 340 litres
- Application: For debinding of metals and ceramics injection moulded parts prior to sintering



Rapid Loading / Unloading Furnaces

- Temperature: 1200°C
- Capacity: 45 litres
- Application: With powered doors for batch heat treatment of springs



High Temperature Mechanical Testing Furnaces

- Temperature: 1200°C
- Capacity: 250 litres
- Application: For heating large concrete beams under high temperature mechanical testing



Ceramic Medical Implants Processing

- Temperature: 1700°C
- Capacity: 50 litres
- Application: For processing of ceramic medical implants



Trolley Loading Elevator Hearth Furnaces

- Temperature: 1700°C
- Capacity: 270 litres
- Application: For sintering high precision technical ceramics



Split Chamber Furnace

- Temperature: 1200°C
- Application: For heating racing car parts under fatigue test conditions



Horizontal & Vertical
Tube Furnaces
up to 1850°C

Standard and Customized Tube Furnaces for Research & Industrial Applications

Tube Furnaces up to 1850°C

Single Zone, Multi Zone
Horizontal, Vertical, Split
Rotating, Vacuum & Custom Designed



Elite Thermal offers a wide range of standard and custom designed tube furnaces which are widely used in Educational, Research and Industrial organisations throughout the world.

This design and engineering capability enables Elite Thermal, and its representatives, to service contracts ranging from laboratory scale to full scale batch and continuous production of equipment.

The tube furnaces from Elite Thermal are intended for use at up to 1850°C. They come in a variety of tube diameters / lengths single and multi-heated zones, split (horizontal or vertical), rotating, vacuum options and many other configurations.

Tube Furnaces Single Zone

1200°C to 1850°C Maximum

Single zone Tube furnaces for temperatures 1200°C, 1400°C, 1500°C, 1600°C, 1700°C, 1750°C, 1800°C & 1850°C
TSH & TSV – This comprehensive range of furnaces offers 83 standard models with an operating temperature range of above ambient to 1850°C.

1200°C, 1400°C, 1500°C & 1600°C models are all bench mounted and have protective outer mesh covers for improved operator safety with all other models being floor standing. 1700°C, 1750°C, 1800°C & 1850°C models are all floor mounted high temperature single zone tube furnaces.

Horizontal Tube Furnaces

TSH12

1200°C Maximum

The TSH12 furnace is a bench mounted tube furnace ideal for most general laboratory thermal processing applications.

Standard Features:

- | The furnace design incorporates an integral elemental tube
- | Protective outer mesh covers for improved operator safety
- | Low thermal mass insulation is used throughout for rapid response rates and maximum efficiency and stability
- | For aggressive processes, a separate work tube is recommended to minimise the risk of contaminating the elemental work tube
- | A rugged metal sheathed control thermocouple is protected from accidental damage and allows full use of work tube bore

- | Controls are located at the base of the furnace
- | 'N' Type thermocouple is used in these furnaces
- | High end Microprocessor PID controller

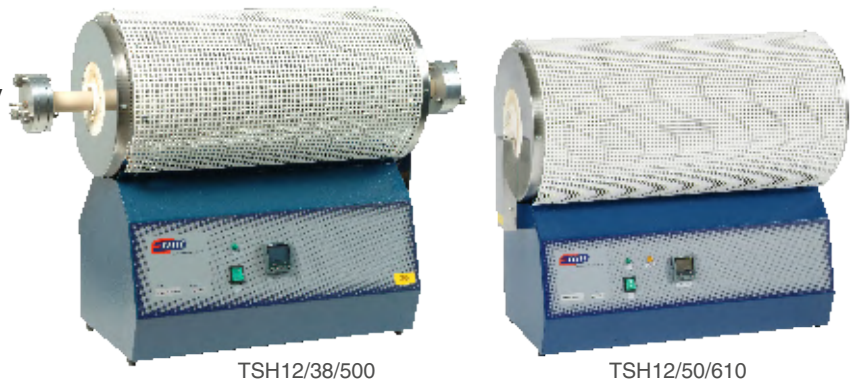

TSH12/38/500

TSH12/50/610

Options:

- | Additional Work tubes of various materials, lengths and diameters for use in the furnace
- | The work tubes are available for containment of atmosphere or protection against process contaminants
- | A variety of triple flange gas tight end seals for work tubes to allow processing under vacuum or gas atmospheres
- | Multi segment, multi program storage controllers
- | Over temperature protection controllers

Heating elements: Special arrangement via resistance wire wound onto a ceramic worktube which is an integral part of the furnace gives optimum temperature uniformity throughout the furnace.

Technical Data:

Model	Max Temp (°C)	Max Cont (°C)	Tube Diameter (ID) (mm)	Heated Length (mm)	Nominal Power (Kw)	Volts	Phase	Ext Dimensions (mm) H x W x D	Net Wt. (kg)	Additional Worktubes (ID x Length) mm	
										Short	Long
TSH12/25/250	1200	1150	25	250	0.8	230	1	560 x 335 x 315	11	16 x 350	16 x 500
TSH12/25/500	1200	1150	25	500	1.2	230	1	560 x 585 x 315	16	16 x 600	16 x 750
TSH12/38/250	1200	1150	38	250	1.0	230	1	560 x 335 x 315	12	25 x 350	25 x 500
TSH12/38/500	1200	1150	38	500	1.7	230	1	560 x 585 x 315	16	25 x 600	25 x 750
TSH12/50/300	1200	1150	50	300	1.7	230	1	560 x 385 x 315	14	38 x 400	38 x 600
TSH12/50/610	1200	1150	50	610	2.0	230	1	620 x 700 x 330	21	38 x 700	38 x 900
TSH12/75/610	1200	1150	75	610	2.8	230	1	620 x 700 x 330	26	60 x 900	60 x 1050
TSH12/75/750	1200	1150	75	750	3.0	230	1	620 x 840 x 330	30	60 x 900	60 x 1050
TSH12/100/940	1200	1150	100	940	4.3	230	1	650 x 1025 x 370	45	75 x 1050	75 x 1500

Note: The TSH12 comes with an integral work tube. The additional work tubes are for use within the integral work tube.

Custom Designed For all Tube furnaces, Elite Thermal manufactures custom-built furnaces. Please contact us with your requirement.

Vertical Tube Furnaces

TSV12

1200°C Maximum

The TSV12 furnaces come as a bench mounted tube furnace as well as a floor mounted tube furnace ideal for most general laboratory thermal processing applications.

Standard Features:

- The standard features of TSV12 are same as that of TSH12
- This Vertical furnace comes with a separate control console

Options:

- Optional accessories for TSV12 are same as that for TSH12

Heating elements: The heating elements are same as that for TSH12



TSV12/50/300



TSV12/75/750



TSV12
Furnace with Lift / Lower System

Technical Data:

Model	Max Temp (°C)	Max Cont (°C)	Tube Diameter (ID) (mm)	Heated Height (mm)	Nominal Power (Kw)	Volts	Phase
TSV12/25/250	1200	1150	25	250	0.8	230	1
TSV12/25/500	1200	1150	25	500	1.2	230	1
TSV12/38/250	1200	1150	38	250	1.0	230	1
TSV12/38/500	1200	1150	38	500	1.7	230	1
TSV12/50/300	1200	1150	50	300	1.7	230	1
TSV12/50/610	1200	1150	50	610	2.0	230	1
TSV12/75/610	1200	1150	75	610	2.8	230	1
TSV12/75/750	1200	1150	75	750	3.0	230	1
TSV12/100/940	1200	1150	100	940	4.3	230	1

Product Quality All Elite Thermal Tube Furnaces are designed and manufactured to meet the highest standards of Quality, Reliability and Operator Safety.

Horizontal Tube Furnaces

TSH14, 15 & 16

1400°C, 1500°C & 1600°C Maximum

Standard Features:

- | These models are heated by axially mounted silicon carbide elements around the worktube. These ensure fast heat up and excellent temperature uniformity
- | Controls are located at the base of the furnace
- | This furnace design requires the use of a separate work tube of a grade suitable for the maximum temperature rating of the respective furnace model
- | This family of furnaces is ideal for most laboratory high temperature processing applications



TSH14/50/450

Options:

- | Thermal Radiation Plugs
- | Multi segment, multi program storage controllers
- | Over temperature protection controllers
- | A variety of triple flange gas tight end seals to allow processing under vacuum or gas atmospheres
- | A wide range of work tubes are available for containment of atmosphere or protection against process contaminants

Technical Data:

Model	Max Temp (°C)	Max Cont (°C)	Tube Diameter (ID) (mm)	Heated Length (mm)	Nominal Power (Kw)	Volts	Phase	Ext Dimensions (mm) H x W x D	Net Wt. (kg)	Worktubes (ID x Length) mm	
										Short	Long
TSH14/25/180	1400	1350	25	180	1.5	230	1	610 x 585 x 415	22	25 x 600	25 x 750
TSH14/50/180	1400	1350	50	180	1.5	230	1	610 x 585 x 415	22	50 x 600	50 x 800
TSH14/25/450	1400	1350	25	450	4.5	230	1	715 x 1000 x 460	70	25 x 1050	25 x 1200
TSH14/50/450	1400	1350	50	450	4.5	230	1	715 x 1000 x 460	70	50 x 1050	50 x 1200
TSH14/75/450	1400	1350	75	450	4.5	230	1	715 x 1000 x 460	70	75 x 1050	75 x 1200
TSH14/25/610	1400	1350	25	610	5.75	230	1	715 x 1150 x 460	75	25 x 1200	25 x 1350
TSH14/50/610	1400	1350	50	610	5.75	230	1	715 x 1150 x 460	75	50 x 1200	50 x 1350
TSH14/75/610	1400	1350	75	610	5.75	230	1	715 x 1150 x 460	75	75 x 1200	75 x 1350
TSH15/25/180	1500	1450	25	180	1.5	230	1	610 x 585 x 415	22	25 x 600	25 x 750
TSH15/50/180	1500	1450	50	180	1.5	230	1	610 x 585 x 415	22	50 x 600	50 x 800
TSH15/25/450	1500	1450	25	450	4.5	230	1	715 x 1000 x 460	70	25 x 1050	25 x 1200
TSH15/50/450	1500	1450	50	450	4.5	230	1	715 x 1000 x 460	70	50 x 1050	50 x 1200
TSH15/75/450	1500	1450	75	450	4.5	230	1	715 x 1000 x 460	70	75 x 1050	75 x 1200
TSH15/25/610	1500	1450	25	610	6.0	230	1	715 x 1150 x 460	75	25 x 1200	25 x 1350
TSH15/50/610	1500	1450	50	610	6.0	230	1	715 x 1150 x 460	75	50 x 1200	50 x 1350
TSH15/75/610	1500	1450	75	610	7.0	230	1	715 x 1150 x 460	75	75 x 1200	75 x 1350
TSH16/25/180	1600	1550	25	180	1.5	230	1	610 x 585 x 415	22	25 x 600	25 x 750
TSH16/50/180	1600	1550	50	180	1.5	230	1	610 x 585 x 415	22	50 x 600	50 x 900
TSH16/25/450	1600	1550	25	450	5.0	400	3	715 x 1000 x 460	70	25 x 1050	25 x 1200
TSH16/50/450	1600	1550	50	450	5.0	400	3	715 x 1000 x 460	70	50 x 1050	50 x 1350
TSH16/75/450	1600	1550	75	450	5.0	400	3	715 x 1000 x 460	70	75 x 1050	75 x 1350
TSH16/25/610	1600	1550	25	610	7.0	400	3	825 x 1150 x 562	75	25 x 1200	25 x 1350
TSH16/50/610	1600	1550	50	610	7.0	400	3	825 x 1150 x 562	75	50 x 1200	50 x 1500
TSH16/75/610	1600	1550	75	610	8.0	400	3	825 x 1150 x 562	75	75 x 1200	75 x 1500

Custom Designed For all Tube furnaces, Elite Thermal manufactures custom-built furnaces. Please contact us with your requirement.

Vertical Tube Furnaces

TSV14, 15 & 16

1400°C, 1500°C & 1600°C Maximum

Standard Features:

- The standard features of TSV14, 15 & 16 are same as that of TSH14, 15 & 16 respectively
- The controls for these vertical furnaces come as a separate console

Options:

- Optional accessories for TSV14, 15 & 16 are the same as that of TSH14, 15 & 16 respectively



Technical Data:

Model	Max Temp (°C)	Max Cont (°C)	Tube Diameter (ID) (mm)	Heated Height (mm)	Nominal Power (Kw)	Volts	Phase
TSV14/25/180	1400	1350	25	180	1.5	230	1
TSV14/50/180	1400	1350	50	180	1.5	230	1
TSV14/25/450	1400	1350	25	450	4.5	230	1
TSV14/50/450	1400	1350	50	450	4.5	230	1
TSV14/75/450	1400	1350	75	450	4.5	230	1
TSV14/25/610	1400	1350	25	610	5.75	230	1
TSV14/50/610	1400	1350	50	610	5.75	230	1
TSV14/75/610	1400	1350	75	610	5.75	230	1
TSV15/25/180	1500	1450	25	180	1.5	230	1
TSV15/50/180	1500	1450	50	180	1.5	230	1
TSV15/25/450	1500	1450	25	450	4.5	230	1
TSV15/50/450	1500	1450	50	450	4.5	230	1
TSV15/75/450	1500	1450	75	450	4.5	230	1
TSV15/25/610	1500	1450	25	610	6.0	230	1
TSV15/50/610	1500	1450	50	610	6.0	230	1
TSV15/75/610	1500	1450	75	610	7.0	230	1
TSV16/25/180	1600	1550	25	180	1.5	230	1
TSV16/50/180	1600	1550	50	180	1.5	230	1
TSV16/25/450	1600	1550	25	450	5.0	400	3
TSV16/50/450	1600	1550	50	450	5.0	400	3
TSV16/75/450	1600	1550	75	450	5.0	400	3
TSV16/25/610	1600	1550	25	610	7.0	400	3
TSV16/50/610	1600	1550	50	610	7.0	400	3
TSV16/75/610	1600	1550	75	610	8.0	400	3

Product Quality All Elite Thermal Tube Furnaces are designed and manufactured to meet the highest standards of Quality, Reliability and Operator Safety.

Horizontal Tube Furnaces TSH17, 18 & 185 1700°C, 1800°C & 1850°C Maximum

Standard Features:

- The TSH17 & and TSH18 furnace models are floor-mounted, horizontal tube furnaces designed for a wide range of general laboratory thermal processing applications
- These models are heated on both front and rear sides of the chamber by molybdenum Disilicide elements or Molybdenum Tungsten Disilicide elements
- Work tube is not supplied as an integral part of the furnace and therefore needs to be ordered with the furnace as it is an essential accessory
- Single Phase angle fired thyristor unit in conjunction with a low voltage secondary winding isolating transformer providing the correct operating parameters for the heating elements.
- Over temperature protection is fitted as a standard

Options:

- Work tubes of various materials, lengths and diameters for use in the furnace
- A variety of triple flange gas tight end seals to allow processing under vacuum (up to 1500°C maximum) or gas atmospheres
- Multi segment, multi program storage controllers
- Thermal Radiation Plugs



TSH17/75/450

Technical Data:

Model	Max Temp (°C)	Max Cont (°C)	Tube Diameter (ID) (mm)	Heated Length (mm)	Nominal Power (Kw)	Volts	Phase	Ext Dimensions (mm) H x W x D	Net Wt. (kg)	Worktubes (ID x Length) mm	
										Short	Long
TSH17/75/300	1700	1650	75	300	6.0	230	1	1500 x 625 x 650	220	75 x 700	75 x 1000
TSH17/75/450	1700	1650	75	450	9.0	230	1	1500 x 775 x 650	265	75 x 900	75 x 1200
TSH17/75/600	1700	1650	75	600	12.0	400	3+N	1500 x 925 x 650	-	75 x 1100	75 x 1350
TSH18/40/300	1800	1750	40	300	Details upon request						
TSH18/75/300	1800	1750	75	300	6.0	230	1	1500 x 675 x 650	220	75 x 700	75 x 1000
TSH18/75/450	1800	1750	75	450	9.0	230	1	1500 x 825 x 650	265	75 x 900	75 x 1200
TSH18/75/600	1800	1750	75	600	12.0	400	3	1500 x 975 x 650	-	75 x 1100	75 x 1350
TSH185/40/300	1850	1800	40	300	8.1	230	1	1600 x 600 x 575	226	38 x 650	38 x 900

Vertical Tube Furnaces TSV17 & 18 1700°C and 1800°C Maximum

Standard Features:

- The standard features of the TSV17 and TSV18 are the same as that of TSH17 & TSH18 respectively.
- These vertical furnaces come with a separate console.

Options:

- Optional accessories for the TSV17 and TSV18 are the same as those for the TSH17 and TSH18.



TSV18/75/600

Technical Data:

Model	Max Temp (°C)	Max Cont (°C)	Tube Diameter (ID) (mm)	Heated Height (mm)	Nominal Power (Kw)	Volts	Phase	Ext Dimensions Across Flats (mm) (Hexagon)	Net Wt. (kg)	Worktubes (ID x Length) mm	
										Short	Long
TSV17/75/300	1700	1650	75	300	4.5	230	1	910 x 650	-	75 x 1050	75 x 1350
TSV17/75/450	1700	1650	75	450	5.5	230	1	1060 x 650	-	75 x 1200	75 x 1500
TSV17/75/600	1700	1650	75	600	7.0	230	1	1210 x 650	-	75 x 1350	75 x 1650
Model	Max Temp (°C)	Max Cont (°C)	Tube Diameter (ID) (mm)	Heated Height (mm)	Nominal Power (Kw)	Volts	Phase	Ext Dimensions Across Flats (mm) (Hexagon)	Net Wt. (kg)	Worktubes (ID x Length) mm	
TSV18/75/300	1800	1750	75	300	5.0	230	1	910 x 650	-	75 x 1050	75 x 1350
TSV18/75/450	1800	1750	75	450	6.0	230	1	1060 x 650	-	75 x 1200	75 x 1500
TSV18/75/600	1800	1750	75	600	7.5	230	1	1210 x 650	-	75 x 1350	75 x 1650

Custom Designed For all Tube furnaces, Elite Thermal manufactures custom-built furnaces. Please contact us with your requirement.

Standard Features:

- | The TSV175 furnace is a vertical tube furnace with a separate control panel for most common laboratory thermal processing applications
- | These models are heated by lanthanum chromite elements suspended parallel to the work tube
- | A work tube is not supplied as an integral part of the furnace and therefore needs to be ordered with the furnace as it is an essential accessory
- | Temperature Sensor: 'B' Type Thermocouple
- | Over temperature protection is fitted as a standard

Options:

- | Work tubes of various materials, lengths and diameters for use in the furnace
- | A variety of triple flange gas tight end seals to allow processing under vacuum (up to 1500°C maximum) or gas atmospheres
- | Multi segment, multi program storage controllers
- | Thermal Radiation Plugs



Model	Max Temp (°C)	Max Cont (°C)	Tube Diameter (ID) (mm)	Heated Height (mm)	Nominal Power (Kw)	Volts	Phase	Ext Dimensions Across Flats (mm) (Hexagon)	Net Wt. (kg)	Worktubes (ID x Length) mm	
										Short	Long
TSV175/50/200	1750	1700	50	200	8.3	230	1	-	100	50 x 900	50 x 1200
TSV175/75/350	1750	1700	75	350	12.0	400	3	-	120	75 x 1000	75 x 1350
TSV175/110/350	1750	1700	110	350	12.0	400	3	-	145	110 x 1000	110 x 1500

Product Quality All Elite Thermal Tube Furnaces are designed and manufactured to meet the highest standards of Quality, Reliability and Operator Safety.

Split Horizontal Tube Furnaces – Single Zone

1100°C & 1200°C Maximum

The TSHH split tube furnace is designed to meet the needs of 'in-line' thermal processes, and for when rapid cooling is required.

Standard Features:

- | This furnace is bench mounted and can be supplied with controls mounted as an integral part of the furnace body or in a remote console on two meters of interconnecting cables
- | This Horizontal furnace body is split into two halves and hinged at the rear.
- | The ability to open the furnace makes it easier for operators to exchange the work tube or insert vessels
- | Energy efficient, high quality, low thermal mass insulation provides fast heating and cooling
- | A work tube is not supplied as an integral part of the furnace and therefore needs to be ordered with the furnace as it is an essential accessory
- | The furnace accepts a range of work tubes up to 90mm outside diameter when used with tube reducer inserts
- | 'N' type thermocouple is used in these furnaces
- | High end Microprocessor PID controller



TSHH12/90/305

Options:

- | Work tubes of various materials, lengths and diameters for use in the furnace
- | The work tubes are available for containment of atmosphere or protection against process contaminants.
- | A variety of triple flange gas tight end seals for work tubes to allow processing under vacuum or gas atmospheres.
- | Multi segment, multi program storage controllers
- | Over temperature controllers

Heating elements:

Free radiating high grade resistance wire elements supported on ceramic tubes



Technical Data:

Model	Max Temp (°C)	Max Cont (°C)	Furnace Bore Size (mm)	Heated Length (mm)	Nominal Power (Kw)	Volts	Phase	Ext Dimensions (mm) H x W x D	Net Wt. (kg)	Worktubes (ID x Length) mm	
										Short	Long
TSHH11/90/305	1100	1050	90	305	2.1	230	1	538 x 405 x 660	37	75 x 450	75 x 700
TSHH11/90/457	1100	1050	90	457	2.8	230	1	538 x 557 x 660	46	75 x 600	75 x 900
TSHH11/90/610	1100	1050	90	610	4.2	230	1	538 x 710 x 660	72	75 x 750	75 x 1050
TSHH12/90/305	1200	1150	90	305	2.1	230	1	538 x 405 x 660	37	75 x 450	75 x 700
TSHH12/90/457	1200	1150	90	457	3.0	230	1	538 x 557 x 660	46	75 x 600	75 x 900
TSHH12/90/610	1200	1150	90	610	5.0	230	1	538 x 710 x 660	72	75 x 750	75 x 1050
TSHH12/90/940	1200	1150	90	940	6.0	230	1	538 x 1040 x 660	90	75 x 1050	75 x 1500

Product Quality All Elite Thermal Tube Furnaces are designed and manufactured to meet the highest standards of Quality, Reliability and Operator Safety.

Vertical Split Tube Furnaces TSVH11 & 12 1100°C & 1200°C Maximum

The TSVH11 & 12 furnaces come as a bench mounted tube furnace as well as a floor mounted tube furnace ideal for most general laboratory thermal processing applications.

Standard Features:

- | The standard features of TSVH11 & 12 are the same as that of TSHH11 & 12
- | These vertical furnaces come with a separate control console

Options:

- | Optional accessories for TSVH11 & 12 are the same as that for TSHH11 & 12

Heating elements: The heating elements are the same as that for TSHH11 & 12



TSVH11

Technical Data:

Model	Max Temp (°C)	Max Cont (°C)	Furnace Bore Size (mm)	Heated Height (mm)	Nominal Power (Kw)	Volts	Phase	Ext Dimensions (mm) H x W x D	Net Wt. (kg)	Worktubes (ID x Length) mm	
										Short	Long
TSVH11/90/305	1100	1050	90	305	2.1	230	1	538 x 405 x 660	37	75 x 450	75 x 700
TSVH11/90/457	1100	1050	90	457	2.8	230	1	538 x 557 x 660	46	75 x 600	75 x 900
TSVH11/90/610	1100	1050	90	610	4.2	230	1	538 x 710 x 660	72	75 x 750	75 x 1050
TSVH12/90/305	1200	1150	90	305	2.1	230	1	538 x 405 x 660	37	75 x 450	75 x 700
TSVH12/90/457	1200	1150	90	457	3.0	230	1	538 x 557 x 660	46	75 x 600	75 x 900
TSVH12/90/610	1200	1150	90	610	5.0	230	1	538 x 710 x 660	72	75 x 750	75 x 1050
TSVH12/90/940	1200	1150	90	940	6.0	230	1	538 x 1040 x 660	90	75 x 1050	75 x 1500

Vertical Split Tube Furnaces TSVH17 1700°C Maximum

The TSVH17 model is available in only one standard format as set out in the table below. Alternative heated lengths and/or tube diameters can be manufactured to meet specific customer requirements.

Standard Features:

- | This model is heated by molybdenum disilicide elements
- | Work tube is not a standard supply and need to be ordered along with furnace
- | Over temperature protection is included in the standard specification

Optional:

- | Separate worktubes with triple flange gas tight end seals allow processing under vacuum (up to 1500° C maximum) or gas atmospheres
- | Multi segment, multi program storage controllers

Technical Data:

Model	Max Temp (°C)	Max Cont (°C)	Furnace Bore Size (mm)	Heated Height (mm)	Nominal Power (Kw)	Volts	Phase	Ext Dimensions (mm) H x W x D	Net Wt. (kg)	Worktubes (ID x Length) mm	
										Short	Long
TSVH17/90/250	1700	1650	90	250	4.5	230	1	570 x 650 x 650	70	75 x 600	75 x 900



TSVH17/90/250

Custom Designed For all Tube furnaces, Elite Thermal manufactures custom-built furnaces. Please contact us with your requirement.

Multi Zone Horizontal - 3 Zone

1200°C, 1500°C, 1600°C, 1700°C and 1800°C Maximum

Standard Features:

- TMH – The TMH furnaces are designed to give a longer uniform centre zone temperature than that of the single zone tube furnace models. All TMH models are controlled by retransmission of set point from the centre zone controller to the end zone controllers
- This system provides a longer uniform zone temperature than that achieved by the use of single zone furnace of the same length
- Independent control of each zone is also available
- Controls are located at the base of the furnace

Note:

- 1700°C & 1800°C models are usually floor standing models
- Over temperature protection is included in the standard specification for 1700°C & 1800°C models

Options:

- Over temperature protection controllers
- A wide range of furnace worktubes are available
- A variety of triple flange gas tight end seals to allow processing under vacuum (up to 1500°C maximum) or gas atmospheres
- Multi segment, multi program storage controllers

Technical Data:

Model	Max Temp (°C)	Max Cont (°C)	Tube Diameter (ID) (mm)	Heated Length (mm)	Nominal Power (Kw)	Volts	Phase	Ext Dimensions (mm) H x W x D	Net Wt. (kg)	Additional Worktubes (ID x Length) mm	
										Short	Long
TMH12(Z3)/38/500	1200	1150	38	500	1.8	230	1	560 x 605 x 315	16	25 x 600	25 x 750
TMH12(Z3)/50/610	1200	1150	50	610	2.0	230	1	620 x 720 x 330	21	38 x 700	38 x 1050
TMH12(Z3)/75/750	1200	1150	75	750	2.7	230	1	620 x 860 x 330	30	57 x 900	57 x 1050
TMH12(Z3)/100/940	1200	1150	100	940	5.2	230	1	650 x 1045 x 370	45	75 x 1050	75 x 1500

Note: The TMH12 comes with an integral work tube. The additional work tubes are for use within the integral work tube.

Model	Max Temp (°C)	Max Cont (°C)	Tube Diameter (ID) (mm)	Heated Length (mm)	Nominal Power (Kw)	Volts	Phase	Ext Dimensions (mm) H x W x D	Net Wt. (kg)	Worktubes (ID x Length) mm	
										Short	Long
TMH15(Z3)/50/450	1500	1450	50	450	4.5	400	3	715 x 1000 x 460	55	50 x 1050	50 x 1200
TMH15(Z3)/75/450	1500	1450	75	450	5.0	400	3	715 x 1000 x 460	55	75 x 1050	75 x 1200
TMH15(Z3)/50/610	1500	1450	50	610	5.0	400	3	715 x 1000 x 460	65	50 x 1200	50 x 1350
TMH15(Z3)/75/610	1500	1450	75	610	6.0	400	3	715 x 1150 x 460	65	75 x 1200	75 x 1350
TMH15(Z3)/90/610	1500	1450	90	610	7.5	400	3	715 x 1150 x 460	68	90 x 1200	90 x 1450
TMH16(Z3)/50/450	1600	1550	50	450	4.0	400	3	715 x 1000 x 460	60	50 x 1050	50 x 1200
TMH16(Z3)/75/450	1600	1550	75	450	6.0	400	3	715 x 1000 x 460	60	75 x 1050	75 x 1350
TMH16(Z3)/50/610	1600	1550	50	610	6.0	400	3	825 x 1150 x 562	70	50 x 1200	75 x 1500
TMH16(Z3)/75/610	1600	1550	75	610	6.0	400	3	825 x 1150 x 562	70	75 x 1200	75 x 1500
TMH16(Z3)/90/610	1600	1550	90	610	9.0	400	3	825 x 1150 x 562	70	90 x 1200	90 x 1500
TMH17(Z3)/50/450	1700	1650	50	450	9.0	230	1	1550 x 835 x 650	280	50 x 900	50 x 1200
TMH17(Z3)/75/450	1700	1650	75	450	9.0	230	1	1550 x 835 x 650	280	75 x 900	75 x 1200
TMH17(Z3)/50/610	1700	1650	50	610	10.0	230	1	1550 x 995 x 650	310	50 x 1200	50 x 1500
TMH17(Z3)/75/610	1700	1650	75	610	10.0	230	1	1550 x 995 x 650	310	75 x 1200	75 x 1500
TMH18(Z3)/50/450	1800	1750	50	450	9.0	230	1	1550 x 835 x 650	280	50 x 900	50 x 1200
TMH18(Z3)/75/450	1800	1750	75	450	9.0	230	1	1550 x 835 x 650	280	75 x 900	75 x 1200
TMH18(Z3)/50/610	1800	1750	50	610	10.0	230	1	1550 x 995 x 650	310	50 x 1200	50 x 1500
TMH18(Z3)/75/610	1800	1750	75	610	10.0	230	1	1550 x 995 x 650	310	75 x 1200	75 x 1500

For Multi-zone Tube furnaces, we can supply:

- Two or more zones
- Other temperatures that are not specified
- Other Tube diameters and lengths that are not specified.



TMH14(Z3)-15-16 Style-3 Zone



TMH18(Z3)

Multi Zone Vertical - 3 Zone 1200°C, 1500°C, 1600°C, 1700°C and 1800°C Maximum

Standard Features:

- The standard features of TMV12, 15, 16, 17 & 18 are the same as that of TMH12, 15, 16, 17 & 18 respectively
- These vertical furnaces come with a separate control console

Options:

- Optional accessories for TMV12, 15, 16, 17 & 18 are the same as that of TMH12, 15, 16, 17 & 18 respectively



TMV15(Z3)

TMV16(Z3)/75/610

Technical Data:

Model	Max Temp (°C)	Max Cont (°C)	Tube Diameter (ID) (mm)	Heated Height (mm)	Nominal Power (Kw)	Volts	Phase
TMV12(Z3)/38/500	1200	1150	38	500	1.8	230	1
TMV12(Z3)/50/610	1200	1150	50	610	2.0	230	1
TMV12(Z3)/75/750	1200	1150	75	750	2.7	230	1
TMV12(Z3)/100/940	1200	1150	100	940	5.2	230	1
TMV15(Z3)/50/450	1500	1450	50	450	4.5	400	3
TMV15(Z3)/75/450	1500	1450	75	450	5.0	400	3
TMV15(Z3)/50/610	1500	1450	50	610	5.0	400	3
TMV15(Z3)/75/610	1500	1450	75	610	6.0	400	3
TMV15(Z3)/90/610	1500	1450	90	610	7.5	400	3
TMV16(Z3)/50/450	1600	1550	50	450	4.0	400	3
TMV16(Z3)/75/450	1600	1550	75	450	6.0	400	3
TMV16(Z3)/50/610	1600	1550	50	610	6.0	400	3
TMV16(Z3)/75/610	1600	1550	75	610	6.0	400	3
TMV16(Z3)/90/610	1600	1550	90	610	9.0	400	3

Model	Max Temp (°C)	Max Cont (°C)	Tube Diameter (ID) (mm)	Heated Height (mm)	Nominal Power (Kw)	Volts	Phase	Ext Dimensions Across Flats (mm) (Hexagon)	Net Wt. (kg)	Worktubes (ID x Length) mm	
										Short	Long
TMV17(Z3)/50/610	1700	1650	50	610	8.0	400	3+N	900 x 800	-	50 x 1200	50 x 1350
TMV17(Z3)/75/610	1700	1650	75	610	8.0	400	3+N	900 x 800	-	75 x 1200	75 x 1350

Model	Max Temp (°C)	Max Cont (°C)	Tube Diameter (ID) (mm)	Heated Height (mm)	Nominal Power (Kw)	Volts	Phase	Ext Dimensions Across Flats (mm) (Hexagon)	Net Wt. (kg)	Worktubes (ID x Length) mm	
										Short	Long
TMV18(Z3)/50/610	1800	1750	50	610	8.5	400	3+N	900 x 800	-	50 x 1200	50 x 1350
TMV18(Z3)/75/610	1800	1750	75	610	8.5	400	3+N	900 x 800	-	75 x 1200	75 x 1350

For Multi-zone Tube furnaces, we can supply:

- Two or more zones
- Other temperatures that are not specified
- Other Tube diameters and height that are not specified

Vacuum Tube Furnaces – Single Zone

1200°C and 1500°C Maximum

Elite Thermal's laboratory scale vacuum furnaces provide high specification systems at very competitive prices. The specifications can be tailored for high vacuum or low vacuum processing specifications with an ultimate vacuum 10^{-5} mbar (with clean empty tube).

The standard systems are only supplied in horizontal format.

Standard Features:

- | Vacuum vessel – ceramic tube with SS triple flange gas tight end seals
- | Rotary pump – 2 stage rotary vane pump
- | Turbo molecular pump
- | Pirani gauge – Full range vacuum monitoring



TSHvc12/75/600

Technical Data:

Model	Max Temp (°C)	Max Cont (°C)	Tube Diameter (ID) (mm)	Heated Length (mm)	Nominal Power (Kw)	Volts	Phase	Ext Dimensions (mm) H x W x D	Net Wt. (kg)	Radiation Screens	
										Ceramic	Metalic
TSHvc12/50/600-HV	1200	1150	50	600	4.0	230	1	1450 x 1850 x 700	195	✓	✓
TSHvc12/50/600-LV	1200	1150	50	600	4.0	230	1	1450 x 1850 x 700	195	✓	✓
TSHvc12/75/600-HV	1200	1150	75	600	4.0	230	1	1450 x 1850 x 700	195	✓	✓
TSHvc12/75/600-LV	1200	1150	75	600	4.0	230	1	1450 x 1850 x 700	195	✓	✓
TSHvc15/50/450-HV	1500	1450	50	450	5.8	230	1	1500 x 1700 x 700	195	✓	✓
TSHvc15/50/450-LV	1500	1450	50	450	5.8	230	1	1500 x 1700 x 700	195	✓	✓
TSHvc15/75/450-HV	1500	1450	75	450	5.8	230	1	1500 x 1700 x 700	195	✓	✓
TSHvc15/75/450-LV	1500	1450	75	450	5.8	230	1	1500 x 1700 x 700	195	✓	✓
TSHvc15/75/600-HV	1500	1450	75	600	5.8	230	1	1500 x 1850 x 700	195	✓	✓
TSHvc15/75/600-LV	1500	1450	75	600	5.8	230	1	1500 x 1850 x 700	195	✓	✓

Optional:

- | 3 zone control
- | Semi/fully automatic vacuum and Heating cycles
- | Low vacuum systems
- | Gas control/safety systems
- | Gas inlets



TSHvc15/75/450

Product Quality All Elite Thermal Tube Furnaces are designed and manufactured to meet the highest standards of Quality, Reliability and Operator Safety.

Multi Position Tube Furnace

TSU

The TSU furnace is a versatile Universal Tube Furnace that can be configured in both horizontal and vertical positions. This flexibility makes it suitable for a range of applications, including sample firing, chemical vapor deposition (CVD), and quenching tests. Position the furnace horizontally or at an angle for growing electronic crystals used in the semiconductor industry, or rotate it vertically for sintering applications.

Available in temperature ranges from 1200°C to 1600°C. This furnace employs silicon carbide heating elements.

Standard Features:

- | The furnace includes an elemental tube designed for use up to 1200°C
- | The TSU is a vertical-mounted universal tube furnace with a separate control console
- | For temperatures above 1200°C, a work tube is not included with the furnace and must be purchased separately as it is an essential accessory
- | A modified standard and specially designed tube furnace mounted on a pivoting mechanism allowing positioning of the furnace at any angle from horizontal to vertical with a solid stop mechanism
- | Furnace supplied with a special stand for use in both horizontal and vertical mode
- | Protective outer mesh covers for improved operator safety
- | For aggressive processes, a separate work tube is recommended to minimise the risk of contaminating the elemental work tube
- | High end microprocessor PID temperature controller to maintain the required temperature



Optional Features:

- | Additional Work tubes of various materials, lengths and diameters for use in the furnace
- | The work tubes are available for containment of atmosphere or protection against process contaminants
- | A variety of triple flange gas tight end seals for work tubes to allow processing under vacuum or gas atmospheres
- | The system can be equipped with an electrically driven rocking device for applications requiring constant motion of a loaded sample, with full guarding provided for the moving parts
- | Multi segment, multi program storage controllers
- | Over temperature protection controllers

Work Tubes

A work tube is an essential accessory for use with Tube Furnaces. All tube furnaces other than those designed with an integral tube need a work tube as a mandatory component to accomplish thermal treatment of samples. Even those furnaces with an integral tube require an additional internal work tube for containment of atmosphere or for protection against process contaminants. The work tube, being a critical part of the furnace, plays an essential role in containing the sample while withstanding high temperatures and maintaining chemical resistance. Different materials are chosen for work tubes based on the intended use, temperature range, and chemical compatibility.

Work tubes are available in a variety of materials in various lengths and diameters. The primary criteria for selecting work tube is the working temperature followed by the physical and nature of samples being treated. Work tubes are selected based on their temperature resistance, chemical stability, and mechanical properties. Quartz and alumina are commonly used for moderate temperature ranges (up to around 1200°C - 1800°C). The right choice of ceramic tube material is essential for ensuring the longevity and performance of tube furnaces in a variety of industrial and laboratory applications.

Work tubes can be supplied with closed one end (COE) or both ends open (OBE) as per the requirement of the application.



Quartz work tube

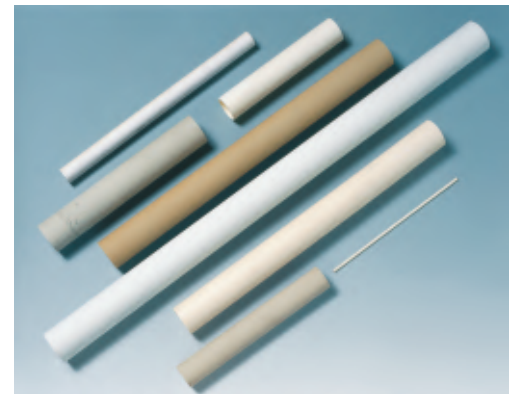

Alumina work tubes

Technical Data:

Tube material	Porous/ Impervious	Physical & chemical properties		Maximum temperatures [°C]		
				in air		under vacuum pressure
				Horizontal	Vertical	Horizontal and Vertical
Sillimanite Tubes	Porous	Good	Good chemical resistance but porous	1500	1600	-
Impervious aluminous	Impervious	Very good	Good chemical resistance against gases, with the exception of fluorine. Resistant to flux sulphurous or carbonaceous atmospheres	1450	1550	1350
Recrystallised alumina Tube	Impervious	Good	Highly resistant to chemical attack, with the exception of fluorine	1800	1900	1500 (Ø 75 mm) 1450 (Ø > 75 to 88 mm)
Quartz Tube	Impervious	Excellent	Generally good but reactive with sodium & at upper temperature limit with metals, carbonates & halides	1150	1200	1150

Insulation End Caps & Plugs

End caps are specialized components designed to seal the tube ends of a furnace. Their primary function is to minimize heat loss at the ends of the furnace and help maintain a more consistent and stable temperature profile during heating. End caps are custom-made to suit specific furnace dimensions and the composition requirements for each application.



End Cap



Insulation Plugs



End Cap

Plugs are designed to be inserted into the furnace or work tubes to prevent heat loss and improve the uniformity of the temperature distribution inside the furnace. Their primary role is to act as insulators to help contain the heat within the furnace and ensure that the heating process is uniform throughout. Insulation plugs are available in a variety of materials and can be customized for different work tube sizes.

Radiation Shields or Screens

Radiation shields/screens serve as an alternative to insulation plugs, particularly in longer work tubes. They are designed to protect against thermal radiation and heat loss by reflecting heat back into the system, thus maintaining a stable temperature within the heated length of the tube. Radiation shields are especially used in vacuum applications where the out gassing of fibre plugs would be undesirable. These shields can be made from materials like alumina and refractory metals that are capable of withstanding high temperatures.



Radiation Shields

Radiation screens/shields and plugs can be used in combination with gas-tight end seals to not only reduce heat losses from the tube ends but also to provide enhanced protection to O-rings in flanged gas tight end seals. The triple flange design ensures a secure, airtight seal, which is essential for maintaining controlled atmospheric conditions in high-temperature environments.

Radiation screens/shields are also used in long work tubes with small heated length.

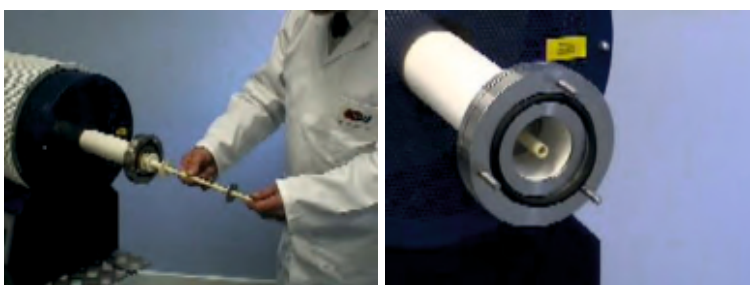

Insertion of the radiation shields in to the work tube

Triple Flange Gas Tight End Seals

Triple Flange Gas Tight End Seals/Work Tube End Seals are required to contain a modified atmosphere and to work with vacuum systems. Vacuum levels of up to 10^{-6} mbar are possible. These are triple flange end seals made of stainless steel and are intended for use with extended work tubes only. They are available to fit work tubes with the following outside diameters: 32, 46, 60, 86, 100, 150, and 200 mm. Other sizes are available at an additional cost.

The following fittings are available for use with the end seals: blank seal, gas nozzle (inlet/outlet), vacuum flanges (NW16, NW25 or NW40), and thermocouple glands ($\varnothing 1.5$ mm, 3 mm, and 10 mm). Where the end seal diameter is large enough, combinations of the above fittings are possible, e.g., gas inlet/outlet nozzle + thermocouple gland.

The end seals are designed for use in combination with insulation plugs or radiation shields. Water-cooled end seals are available upon request. To accommodate the additional weight of the end seals, tube supports are available as optional accessories.



Triple flange end seal with thermocouple gland



Triple flange with gas in/out nozzles



Water cooled flange

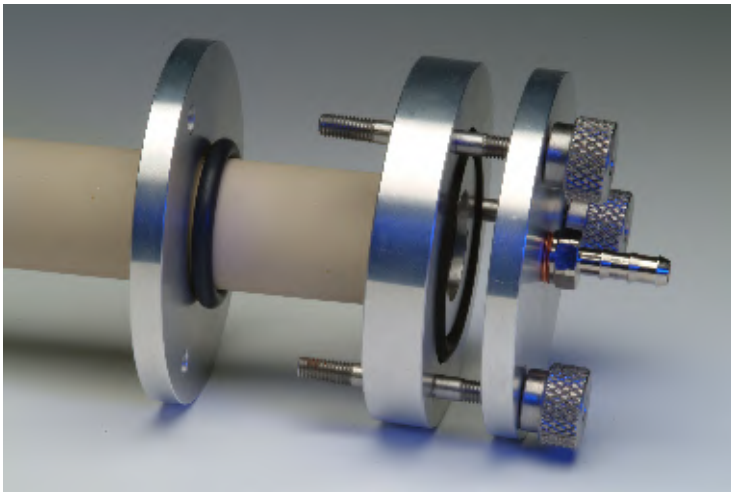

Triple flange assembly

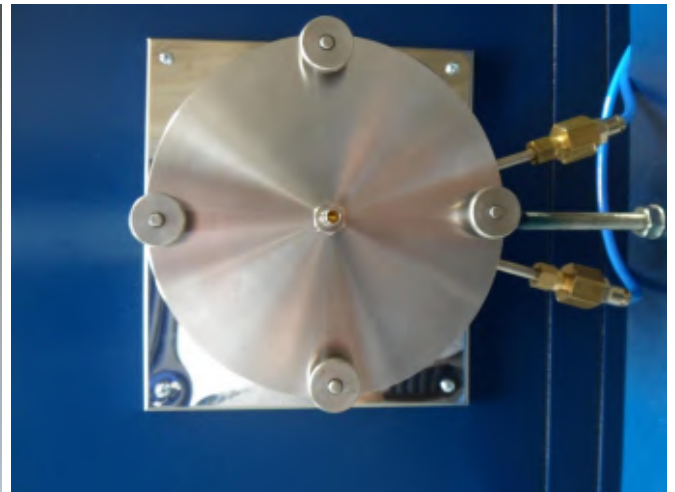

Water cooled flange assembly



Gas and Vacuum triple flanges



Other triple flanges

Crucibles, Boats, Ignition dishes and Plates

- A wide variety of shapes and sizes are available in various grades of ceramics and metals



Personal Safety accessories



- Heat-resistant gloves/thermal gloves protect hands from thermal risks caused by heat. They are suitable for operators working in very hot environments where a high level of protection is required
- Heat resistant aprons provide protection to the body of the operators working in hot environments or handling hot materials in close proximity to the body
- Heat resistant safety goggles and safety shield provide protection to the operator from exposure of eyes to hot/corrosive vapours during loading/removing hot samples to/from furnaces
- A variety of robust charging tongs provide protection to the operator

Flammable Gas control/Safety system

- A full safety system for use with Hydrogen and other combustible gases is available providing timed purging and gas monitoring



Tube supports

Tube supports have two functions:

- To support extended work tubes
- To support extended work tubes with the additional weight of triple flange gas tight end seals



Flowmeter

- With control valve for air or inert gases. For use with gas inlets and work tubes with triple flange gas tight end seals



Temperature Indicator

- An independent digital temperature indicator is built into the furnace control panel and wired to a panel mounted thermocouple socket (for use with an independent monitor thermocouple)



Monitor thermocouple

- An independent thermocouple for use in conjunction with a digital temperature indicator

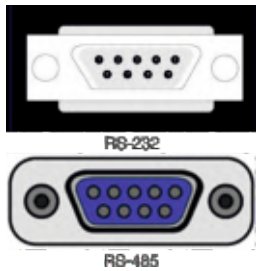
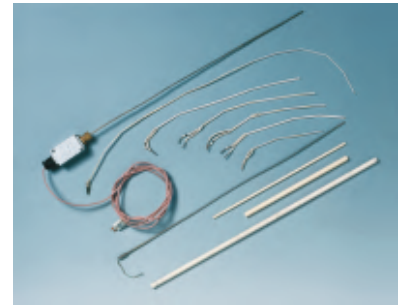

Digital communications

- Digital Communications ports can be fitted to furnaces for external programming or data logging from the temperature controller/programmer(s)
- Connections provided for single instrument RS232 or RS485 standards
- Multi instrument RS485 standard
- Ethernet connections available on certain temperature controllers

Time Switch

- A digital 7 day/24 hour time switch for programmed switch on/off when using basic temperature controllers. A time switch may not be necessary if more sophisticated controllers are fitted

Digital communications Software

- We offer the i-Tools software package for communication between a computer and control instruments
- This software allows setting of instrument control parameters and time/temperature programs from a computer plus starting & stopping of programs and data logging from one or more controllers

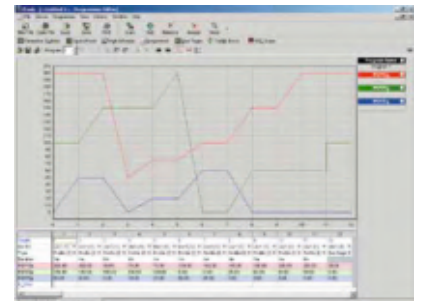

Chart recorders

- Various chart recorders can be supplied ranging from a simple single pen with 100mm wide chart paper to multipoint paperless models

Furnace stands

- A range of horizontal, vertical and universal stand options are available for bench and floor standing furnaces





Horizontal split tube Furnaces

- Temperature: 1100°C
- Capacity: 75mm diameter x 600mm heated length
- Application: For general research work



Tube Furnaces with Lift/lower system

- Temperature: 1100°C
- Application: For use with proprietary electrical test probe equipment



Tube Furnaces with Lift/lower system with probe

- Temperature: 1000°C
- Application: For use with proprietary electrical test probe equipment



3 zone vertical tube furnace

- Temperature: 1500°C
- Capacity: 65 mm diameter x 610 mm heated height
- Application: For biomass fuel research



Research Furnace

- Temperature: 1500°C
- Capacity: 75 mm diameter x 900 mm heated length
- Application: For research and production of carbon nanotubes



Research Furnace

- Temperature: 1700°C
- Capacity: 75 mm diameter x 450 mm heated length
- Application: Horizontal furnace for general high temperature research



3 zone tube furnace

- Temperature: 1300°C
- Capacity: 200 mm diameter x 600 mm heated length
- Application: For treatment of semi conductor wafers



Split tube furnace with load device

- Temperature: 1050°C
- Capacity: 90 mm diameter retort x 600 heated height
- Application: For testing of thermal insulation materials



Vertically split Furnaces

- Temperature: 1200°C
- Capacity: 50 mm diameter retort x 305 heated height
- Application: For use with materials testing probe system



Rotary reactor Furnaces

- Temperature: 1000°C
- Capacity: 15 litres
- Application: Refractory metal reaction vessel for research in use of coal & coke by-products



Rotary reactor Furnaces

- Temperature: 1100°C
- Application: Quartz reactor for R & D in novel powders



Quartz reactor Tube Furnace

- Temperature: 1200°C
- Application: Quartz reactor for determination of oxygen content of copper powders



Twin tube furnace

- Temperature: 1200°C
- Application: Twin 3 zone vertical furnaces used with a winding RIG for annealing fine precious metal wires



3 zone research Furnace

- Temperature: 1700°C
- Capacity: 75 mm diameter x 900 mm heated length
- Application: 3 zone horizontal furnace for general high temperature research



Vertical split tube Furnaces

- Temperature: 1100°C
- Capacity: 75mm diameter x 600mm heated height
- Application: For general research work



Multi Tube Furnace

- Temperature: 1400°C
- Capacity: Four combustion tubes, each with a diameter of 50 mm and length of 720mm
- Application: For baking fluxes and crucibles



3 zone vertical Split furnace

- Temperature: 1200°C
- Application: For use in tensile, fatigue and creep testing equipment



Special Furnaces for Electrical cable insulation

- Temperature: 1200°C
- Application: For determination of evolved gases from heated electrical cables insulation

Elite Thermal offers a selection of microprocessor based control instruments from the Eurotherm range, the following is a guide to the capabilities of the standard range of controllers offered:-

Controller and Programmer Features Guide

Type	Indicator/ Overtemperature Protection	PID	Programmer Level*	Advanced Programmer Level 1	Advanced Programmer Level 2**
Model	3216i	3216cc	35081	3016cp	3016p1
Controller size (mm) (Height x width)	48 x 48	48 x 48	96 x 48	48 x 48	48 x 48
Communications	Optional RS232 or RS485	Optional RS232 or RS485	Optional RS232 or RS485	Optional RS232 or RS485	Optional RS232 or RS485
Display	Dual	Dual	Dual	Dual	Dual
Alarm Display	No/Yes	Yes	Yes	Yes	Yes
Number of Programmes	N/A	None (Ramp to set point)	1	1	1
Number of Segments per Program	N/A	N/A	20 (Free Format)	8 segment	24 segment
Typical Profiles	N/A				

*10 & 25 program versions of this controller with 350810 & 350825 are available.

**10 program version of this controller with 3016P10 is available.

Note:

- 1) Other types of instrumentation/controller can be supplied in accordance with your instructions.
- 2) 3016 and 3508 can be fitted with ethernet comms.



Temperature Controllers, Programmers & Indicators

PID Controller

Eurotherm 3216CC

This 3000 series instrument is a dual display PID controller. A single ramp to setpoint followed by a dwell facility is a standard feature.

Programmable Controllers

Eurotherm 35081

The 35081 is a larger format programmer with multi-line display. It has a single program storage of up to 20 free format segments. It can also be supplied as a dual loop instrument for either cascade control or dual zone control.

Eurotherm 3016CP

3016 CP is a PID Controller with programmer. It has a single program storage of 8 free format segments.

Eurotherm 3016P1

3016 P1 is a PID Controller with programmer. It has a single program storage of 24 free format segments. It is also possible for two relay operated options also.

Eurotherm 3016P10

This version is like the 3016P1 but has more programming capability. The 3016P10 has 10 programs each with 24 segments.

Indicator/Overtemperature Protection

Eurotherm 3216i

An independent digital temperature indicator which is built into the furnace control panel and wired to a panel mounted thermocouple socket. (This is for use with an independent monitor thermocouple).

An independent over-temperature protection system which operates in conjunction with its own independent thermocouple and contactor to shut the furnace down if the controller setpoint is exceeded.

Note: Indicators can also be supplied in a separate mini-console so that, with the addition of a suitable thermocouple, it can be used as an independent portable temperature checker.

4848VRP PID Controller:

4848VRP is a multiprogram/multi segment PID Controller with dual display of set temperature and process variable

Standard Features:

- | 8 pattern profiles
- | 8 segments per pattern
- | Three groups of alarm outputs and each group allows eighteen alarm types in the initial setting mode
- | Panel Water proof level: Ip65
- | RS-485 communication

Touch Screen Controllers

TSC-BAP8 Touch screen controller:

TSC-BA is a multiprogram/multi segment Touch screen controller offering 8 Patterns each with 8 free format segments which allows the user to configure the segments of each pattern as ramp or soak (dwell) as each segment is free to format as per user requirement.

Standard Features:

- | 4.3" TFT LCD colour touch screen, LED Back light
- | Panel mounted USB port
- | Data logging to a USB memory stick in a .csv file format
- | Real time clock
- | 12 Alarm modes based on set value (SV) and process value (PV) in temperature control process
- | Buzzer: Multi-tone frequency of 2-4KHz/80 dB
- | User level security: 3 levels
- | Built-in calendar
- | Serial communication port: RS-485
- | Panel Water proof level: IP65/NEMA 4

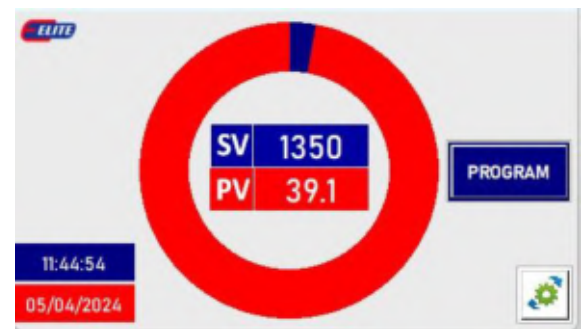

Home Screen (Program Running)

TSC-NLP10 Touch screen controller:

TSC-NL is a multiprogram/multi segment Touch screen controller offering 10 program each with 24 free format segments for applications involving complex temperature profiles for hassle free, smooth and precise temperature control function.

Standard Features:

- | 4.3" TFT LCD colour touch screen, White LED Back light
- | Panel mounted USB port
- | Data logging to a USB memory stick in a .csv file format
- | Real time clock
- | 6 configurable alarms with manual, automatic, non-latching and event types plus alarm delay function and blocking.
- | Audible alarm
- | User level security: 3 levels
- | Two-point user calibration of thermocouple
- | Language setting: English, German, French, Italian, Spanish, Simplified Chinese
- | Multizone version: Retransmission of setpoint
- | Built-in calendar
- | Serial communication port: RS-485
- | Dual Ethernet
- | Panel Water proof level: IP65F



Home Screen (Auto mode)

	Alarm Type	Setpoint	Alarm Icon	Alarm Status
1	AbvHi	1600	🔔	🔴
2	AbsLo	0	🔔	🔴
3	DigHi	1	🔔	🔴
4	Off	1	🔔	🔴
5	DigHi	1	🔔	🔴
6	Off	1	🔔	🔴

Alarms

1) Three Zone Controls - Designed to provide a longer uniform hot zone

Retransmission of Setpoint

This method has the centre zone programmer digitally sending its setpoint to the other zone controllers so ensuring that all instruments follow the same profile.

This method is recommended where controlled cooling is required.

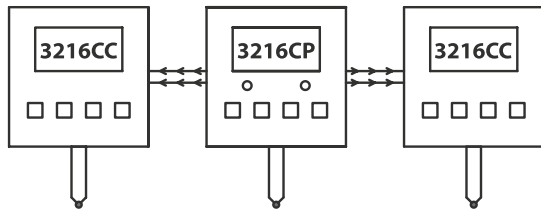

Independent

This method provides three independent controllers each with their own thermocouple. If programming features are required for the application then all zones must be fitted with a programmable controller.

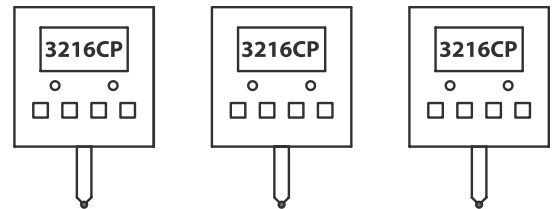

Note: Instrument types other than those shown on schematics are available for both types of multi control systems.

2) Cascade Control - Designed to allow furnace loads to be heated at a faster rate, with more precise control than the standard control system

This control system adds another thermocouple and controller to the basic furnace control system.

The additional thermocouple is placed close to, or in, the load and connected to the main controller (load control).

The other thermocouple senses the temperature close to the heating elements and is connected to the second controller (element control)

Standard Control

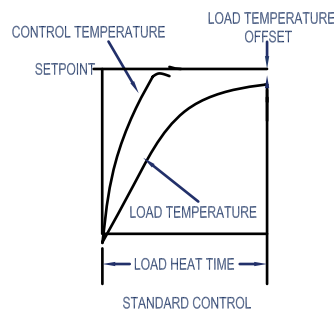

Cascade Control

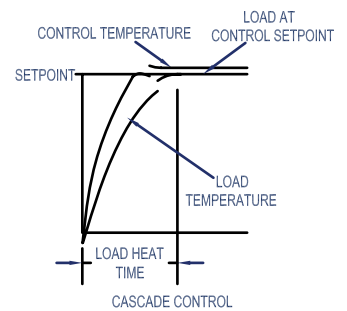

3) PLC Control Systems - Programmable Logic Controllers

Where process applications require the furnace temperature to be integrated with atmosphere control equipment, and/or other mechanical devices, then Elite Thermal is able to provide integrated bespoke PLC control solutions to meet your specific needs.

Digital Communications

Digital communications are available in RS232, & RS485 standards.

The controller communications module is wired to a panel mounted 'D' socket which is normally mounted on the furnace side panel for ease of access.

Note. The communications software, cables & converters are all chargeable options, and therefore if required should be ordered separately.

RS232	Allows a single controller to communicate with a single computer.
RS485	Allows multiple controllers to communicate with a single computer.
Ethernet	Ethernet connection for LAN and Remote communications with the controller. (Enabled controller only).
Software	Elite Thermal offers the I-Tools software package to control the communications between the computer and the temperature controller(s). Other software can be supplied to suit the customer's specific requirements.
Converters	RS232/RS485 converters allow the connection of a RS485 control system to a computer fitted with RS232 communications.

Peak Electrical Power Requirement Explained

We have provided Nominal Power Kw figure in columns for all the furnaces. We can provide peak power for chosen furnace on request.

Peak power: Power to the heating elements is regulated on a time basis by reducing the "ON" time to give an average Power output. However, during the "ON" time, depending on the furnace settings, dictated by the furnace design and heating element type, the elements can consume somewhat higher power which we define as peak power. This peak power can be advised on request. The electrical power supply to the furnace should therefore be rated to carry the peak power. If in doubt, please contact our technical department for peak power advice.

Furnaces Supplied Without Controls

- 1) The full cost of a controller cannot be passed on to the customer because each furnace has to be individually tested which requires a controller to be configured, fitted and removed after testing.
- 2) The furnace is supplied without any warranty because the controller setting/performance is critical to the life of the furnace.

Elite Thermal's technical team has over 40 years experience in the design and maintenance of both laboratory and production scale furnaces. Elite Thermal's personnel take pride in providing the highest possible standard of customer care, together with the delivery of a comprehensive range of services designed to ensure that your furnaces will run safely and efficiently.

The range of services includes

- | Furnace maintenance contracts
- | Furnace temperature distribution surveys
- | Calibration checks on thermocouples & instrumentation
- | Certificates can be supplied with results traceable to U.K. National Standards
- | Results can be certified either on an "In House" basis or, to UCAS standards
- | Certificates of accuracy can be issued for:-
 - The control thermocouple(s) showing accuracy at the number of test temperatures required
 - The temperature controller/programmer(s) can be certified at several different test points, or certified over the full working range
 - The temperature controller/programmer and thermocouple together as a unit
- | Full refurbishment service covering insulation, electrics & instrumentation
- | Thermocouple repair & replacement
- | Equipment upgrades
- | Operator training
- | System safety checks
- | Emergency breakdown attendance

We are pleased to assist in the repair and refurbishment of equipment not of our manufacture

Checklist of information required to place an order.

The following information is essential to enable our sales engineers to identify your precise requirements:-

- | The intended use of the furnace together with a description of the process

This should include:-

- The maximum & continuous operating temperature required
- The load material, type, size & weight
- The type of process is and whether it generates aggressive volatiles or corrosive fumes, etc
- Do you need to process under atmosphere or vacuum?

- | Have you identified a furnace type/model from our literature?

- | What type of controls do you require (simple controllers or Programmable controllers)?

- | The electrical supply, current rating that you have available. (refer below for supply information)

- | Do you have any furnace size/ location restrictions (ie. does it need to fit in a fume cupboard, etc.)?

Typical Supply Voltages

Typical single phase voltages are: 100,110,115,200,208,220,230 & 254 volts • Typical 3 phase voltages without neutral are: 220,380,400,415 & 440 volts • Typical 3 phase voltages with neutral are: 220/127, 380/220, 400/230 and 440/254

Peak Electrical Power Requirement Explained

We have provided Nominal Power Kw figure in columns for all the furnaces. We can provide peak power for chosen furnace on request.

Peak power: Power to the heating elements is regulated on a time basis by reducing the "ON" time to give an average Power output. However, during the "ON" time, depending on the furnace settings, dictated by the furnace design and heating element type, the elements can consume somewhat higher power which we define as peak power. This peak power can be advised on request. The electrical power supply to the furnace should therefore be rated to carry the peak power. If in doubt, please contact our technical department for peak power advice.

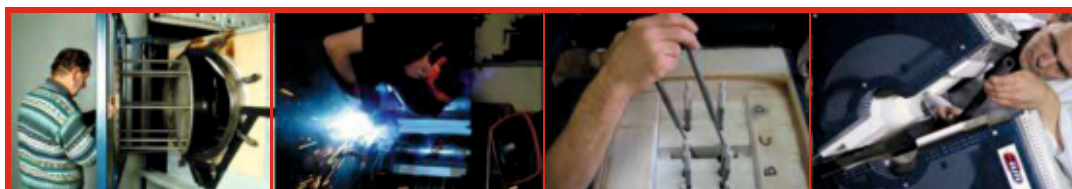

Coal and Coke Testing Equipment

Minimum Free Space Oven, MFSU; MFSO-ISO; MFSO-ASTM

Volatile Matter Furnaces, VMF / ASTM

Volatile Matter Furnaces, VMF / ISO

Ashing Furnaces, BMF11 & BSF12/A

Free Swelling Index Furnace, FSI

Gray King Coke Test Furnace, GKF

Over the years, the variety of coal and coke tests that may be performed in a furnace or oven has been expanded. Elite Thermal has responded to the demands of each new standard by creating furnaces that are tailored to the particular needs of each test technique.

The scope covers international testing and evaluation of test techniques for coal and coke, such as ISO and ASTM.

Minimum Free Space Oven, MFSU/MFSO-ISO/MFSO-ASTM

Minimum Free Space oven is utilized for drying process which features a compact heated chamber that provides the lowest practical volume, or minimum free space.

The MFSO-ISO operates with a regulated flow of moisture free nitrogen gas which removes the moisture released by the coal at 105 °C as per BS 1016-104.2:1991, BS ISO 687:2010 & BS ISO 11722:2013.

The MFSO-ASTM operates with a regulated flow of air as per ASTM D3173-11.

MFSU is a Universal Minimum free space oven as per above ASTM, ISO & BS test methods.

Standard Features:

- | Maximum Temperature: up to 210°C
- | Maximum Continuous Temperature: up to 210°C
- | Chamber dimensions (mm): 43 x 195 x 300 (H x W x D), 2.5 Litres
- | The ovens have an aluminum chamber that resists oxidation and corrosion, resulting in excellent temperature uniformity over the working volume
- | Before accessing the front of the work chamber, the nitrogen or air flow passes through a preheating chamber and is adjustable via a flow meter mounted on the control panel
- | 2 Flow meters to monitor gas flow of Nitrogen & Chamber seal integrity in MFSO-ISO
- | 2 Flow meters to monitor gas flow of Air & Chamber seal integrity in MFSO-ASTM
- | 3 Flow meters to monitor gas flow of Nitrogen, Air & Chamber seal integrity in MFSU
- | Aluminum loading tray is supplied as standard accessory



Optional Features & Accessories:

- | Over temperature protection
- | Multi segment, multi program storage Controllers
- | Silica or Alumina crucibles with well-fitted lids
- | Vacuum desiccator with gas inlet & gas outlet



Crucibles & Lids



Sample loading tray

Note: Analytical balance with 0.01g readability is required for weighing.

Model	Atmosphere	Max. operating temp.(°C)	Chamber dimensions H x W x D (mm)	Volume (litres)	Max. power (W)
MFSU	Nitrogen & Air	210	43 x 195 x 300	2.5	500
MFSO-ISO	Nitrogen	210	43 x 195 x 300	2.5	500
MFSO-ASTM	Air	210	43 x 195 x 300	2.5	500

Volatile Matter Furnace (VMF / ASTM)

The VMF/ASTM is a bench mounted furnace specially designed for determination of volatile matter in coal and coke samples as per ASTM D3175.

Specification:

- | Maximum temperature: up to 1000°C.
- | Continuous operating temperature: up to 1000°C.
- | Top opening furnace as per ASTM D3175.
- | Residual current device (RCD) is fitted to provide enhanced operator safety.
- | High grade resistance wire wound heating elements.
- | Energy efficient, high quality, low thermal mass insulation.
- | A rugged metal sheathed control thermocouple is protected from accidental damage and allows full use of work tube bore.
- | Temperature measurement with 'N' type thermocouple
- | High end microprocessor PID temperature controller to maintain the required temperature as per ASTM D3175.
- | Wire crucible holder along with Inconel crucible & lid are supplied as standard.



VMF/ASTM
(N₂ gas port with flow meter option)

Optional Features & Accessories:

- | N₂ gas port with a flow meter.
- | Over temperature protection controller.
- | Metal cooling block for cooling the crucibles.



Inconel crucible with lid

Note: Analytical balance with 0.01g readability is required for weighing.

Volatile Matter Furnace, VMF / ISO

This is a chamber furnace designed for Volatile Matter Analysis as per ISO 562. This furnace offers temperature and response times to perform Volatile matter determination.

Standard Features:

- | Maximum Temperature: 1100°C
- | Continuous Temperature: 1050°C
- | Chamber dimensions (mm): 110 x 200 x 254 (H x W x D)
- | Heating elements (embedded in ceramic slabs) located on 4 sides of the chamber ensure rapid heating required for analysis as per ISO 562
- | The chimney has a provision to restrict airflow/convection through the furnace
- | Provision for inserting external thermocouples (three positions) to check the temperature under the crucibles
- | Protection of the elements from carbon build-up or corrosive atmosphere, inherent in the slab design, makes it ideal for volatile matter analysis
- | Vertical lifting door keeps the hot face away from the operator when the door is opened
- | Positive break door safety switch isolates heating elements from power supply when door is opened
- | High-end micro-processor PID controller



VMF/ISO



VMF/ISO

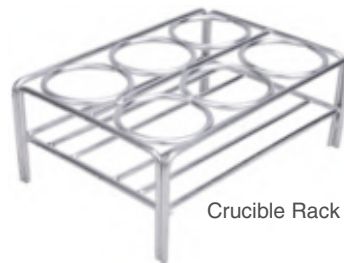

Crucible Rack



Crucible with Lid

Optional Features & Accessories:

- | Over temperature protection controller
- | Multi segment, multi program storage controllers with audible alarm & timer
- | 4, 6 & 9 crucible rack with loading handle available
- | Crucibles and lids are available as per ISO 562
- | Calibrated thermocouple probe with digital indicator

Note: Analytical balance with 0.01g readability is required for weighing.

Ashing Furnaces, BMF11 & BSF12/A

BMF11 & BSF12/A furnaces are designed specially for Ashing applications.

Please refer **page numbers 12 & 13** for more details.

Free Swelling Index Furnace, FSI

The Swelling Index Furnace, often simply called the free swelling Index (FSI) or Crucible Swelling Number (CSN), measures the swelling behaviour of materials.

The cokeability of coal is an important technological parameter of coals during the reduction process. Coking properties of coal are evaluated using the FSI. It is a test that determines the ability of coal to form a coherent mass, or "coke," when heated in the absence of air. This property is crucial for the steel industry, where coking coal is used in the production of coke, a key ingredient in blast furnace operations.

FSI is determined by comparing the size and shape of the coke button with a chart of standard profiles and scaling a value from 0 to 9 at an interval of 0.5.

Standard Features:

- | Maximum temperature: 900°C
- | Continuous operating temperature: Up to 850°C
- | Top opening furnace as per ASTM D720, BS ISO 501 & ISO 501
- | Residual current device (RCD) is fitted to provide enhance operator safety
- | Uses high power resistance heating element
- | Excellent temperature stability and quick temperature ramping
- | Energy efficient, high quality, low thermal mass insulation
- | Temperature measurement with 'N' type thermocouple
- | High end Microprocessor PID temperature controller to maintain the required temperature
- | A set of Crucible and lid supplied as standard for swelling test as per the dimensions given in the test standard
- | Wire Crucible holder supplied as standard



Free Swelling Index Furnace, FSI

Standard Supply:

- | Free Swelling Index Furnace, FSI
- | Silica Crucible – 1 No.
- | Silica Crucible lid – 1 No.
- | Crucible Holding wire – 1 No.
- | Instructions manual – 1 No.



Crucible & Crucible Lid

Optional Features:

- | Over Temperature controller
- | Silica crucible & lid with hole for calibration
- | Ceramic Cooling block for cooling crucibles



Inconel crucible wire

UPCOMING LAUNCHES OF ADDITIONAL COAL AND COKE TESTING EQUIPMENT

| Combustion Tube Furnace

| CO₂ Reactivity Test Furnaces

Gray King Coke Test Furnace, GKF

The Gray King coke test furnace evaluates the caking properties of coal or coal blends by carbonising them under standard conditions.

This test data can be easily compared with industrial practices, allowing for a reliable prediction of how the coal will behave during large-scale carbonisation.

The GKF furnace is designed and complies with standards BS ISO 502:2015, BS 1016-107.2, AS 1038.12.2, IS 1353.

Elite Thermal systems offer the choice of two Gray King coke test furnaces, GFK-1 & GFK-4.

Specifications:

- | Continuous operating Temperature: 600°C
- | Both the models have two zones
- | GFK-1 can hold a single retort tube whilst the GFK-4 can hold up to 4 retort tubes
- | Aluminum bronze stabilisation block which gives improved uniformity of temperature
- | Two thermocouples are located inside the stabilisation block, protected by ceramic sheaths
- | Energy efficient, high quality, low thermal mass insulation
- | High end Microprocessor PID controller & slave controller to maintain the required temperature
- | The furnace is equipped with a wheel and rail system that allows it to be retracted from the retort tubes for cooling, as specified by the Standard
- | Horizontal models are supplied as standard with controls in the base

(Retort tubes should be ordered separately)

Standard Supply:

- | Gray King Coke Test Furnace, GFK
- | Instructions manual - 1 No.

Optional Features:

- | Multi-segment, multi-program storage controller
- | Over temperature protection controller



Retort tube

Thermal Analysers

Thermogravimetric Analysers & Ash Fusion Determinators

Elite Thermal offers thermal analysers for the analysis of Coal, Fuels and Minerals. Elite Thermal has been manufacturing ash fusion determinators for over ten years now and has recently launched their thermogravimetric analysers

Thermogravimetric Analysers

TGA et250

Elite Thermal's Thermogravimetric Analysers (TGAs) are high-performance proximate analysers that measure the weight change of a sample as a function of temperature. They are used to study the thermal stability and composition of materials. Elite Thermal's TGAs are utilised for the determination of moisture, ash, volatile matter, fixed carbon, and loss on ignition (LOI) in a wide range of organic, inorganic, and synthetic materials.

Elite Thermal offers a range of TGAs to meet the needs of different applications. TGA et250 is a versatile instrument that features a programmable furnace and an integrated balance, enabling fast and accurate measurements. TGA et250 can analyse up to 19 samples simultaneously and employs a single carousel design for holding crucibles. TGA et250 is a cost-effective instrument that is ideal for basic TGA applications with manual handling of crucible lids.

Elite Thermal's Thermogravimetric analysers replace traditional analytical techniques that are labour-intensive, slow, and susceptible to operational errors. TGA et250 comes with an integrated balance that combines drying, ashing, and weighing processes, thereby improving efficiency, precision, and providing high sample throughput.

Elite Thermal's TGA systems comply with several international standards, including ASTM, ISO, DIN, EN, and more. Elite Thermal's TGAs find applications in various industries, including coal, coke, mineral ores, cement, limestone, foodstuffs, feeds, and many more.

A typical coal analysis method consists of determining moisture, volatile matter, and ash content. Customisation options within the software encompass temperature ramping, start and end temperatures, gas flow programming, and mass constancy criteria, guaranteeing a fully adaptable instrument that meets the unique demands of every user.

TGA et250 key features

- | Single Carousel design
- | Analysis of up to 19 samples
- | Manual handling of Crucible lids
- | Samples: Organic, Inorganic & Synthetic
- | Parameters: Moisture, Volatiles, Ash, LOI & Fixed Carbon



Robust Heating Elements

- | High power thermal elements facilitate quick temperature ramp-up and provide exceptional temperature stability
- | Embedded heating elements ensure uniform temperature inside the furnace chamber throughout the analysis cycle
- | Higher maximum temperature range up to 1100°C

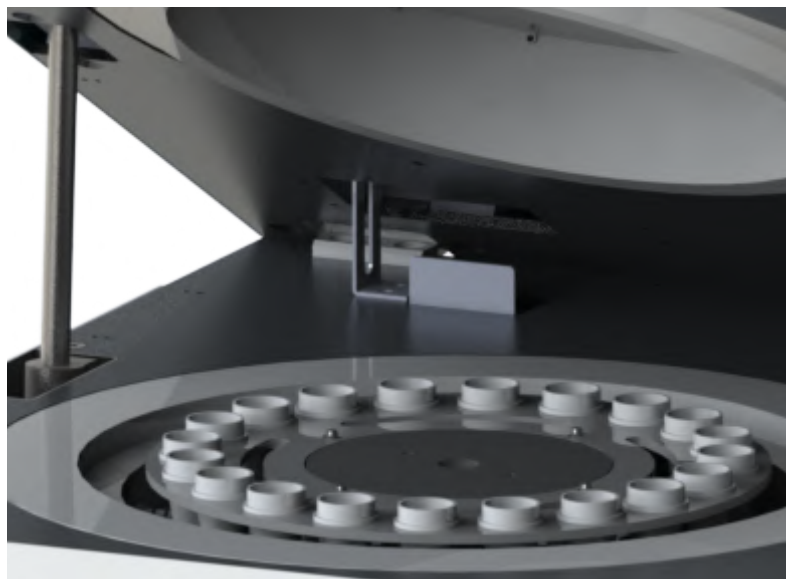

Effective Temperature Control

- | Best-in-class temperature set point control is achieved through the use of two high precision thermocouples
- | The first thermocouple to monitor the furnace temperature. Second thermocouple to monitor the sample temperature precisely
- | Additional thermocouples are available as an optional feature. In addition to the two thermocouples mentioned above, a third thermocouple is provided for monitoring the lower furnace, and a fourth thermocouple provides temperature cross-verification and temperature calibration functionality
- | These third and fourth thermocouples are factory-installed options. They must be ordered along with the main TGA et250 instrument

Precise Weighing System

- | TGA et250 is integrated with a top-loading balance featuring an inbuilt auto-calibration facility and the ability to weigh the sample crucibles repeatedly throughout the analysis
- | Thermally isolated balance for accurate weighing
- | High-resolution balance ensuring accuracy to 0.0001 g for precise results

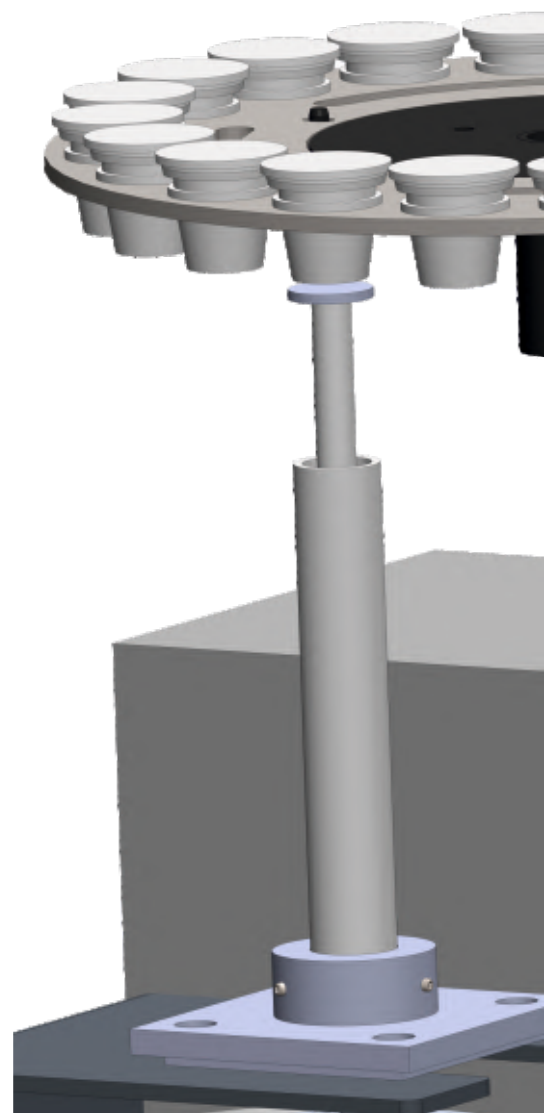

Exceptional Analytical Performance



- | State-of-the-art thermogravimetric analyser featuring robust hardware and user-friendly software encased in a durable design, delivering exceptional analytical capabilities
- | TGA et250 is constructed using high-quality materials, ensuring superior functionality and performance even in challenging conditions, and offering consistent operation and reliability
- | The carousel is constructed from specialised materials that withstand high temperature stress without warping
- | TGA et250 is available in a dual furnace package which allows for two TGAs to be operated from a single PC for laboratories that require the highest sample throughput

Superior Carousel Mechanism



- | Single carousel for holding crucibles with manual handling of crucible lids
- | The carousel accepts 19 samples and 1 reference
- | Carousel MOC: Either Metal or Ceramic
- | Bi-directional movement and ability to skip empty positions for faster analysis times
- | Up-and-down movement of the carousel using pneumatic control and motorised rotation enables precise and accurate analysis without any oscillation

Exhaust & Cooling System

- | In-built exhaust system with two internal blowers minimises harmful vapours and odours in the laboratory
- | Cooldown process is automatically initiated at the end of each analysis cycle
- | User programmable furnace lid opening to improve cool down time
- | Optional external exhaust system is available for even faster cooling

Gas Flows

- | With TGA et250, users can seamlessly transition between oxidizing and inert atmospheres through automated controls
- | An optional feature includes a software-controlled mass flow controller, which enables programmable adjustment of gas flow rates

Thermogravimetric Analysers

TGA et500

The TGA et250 and TGA et500 are essentially the same in terms of features, except that the TGA et500 comes with a dual carousel configuration, differing in their operating mechanisms. The TGA et500 features two carousels for placing crucibles and their lids.

Elite Thermal's TGA et500 is a dual carousel thermogravimetric analyser, distinguished by its unique capability of controlling crucible lids. During typical analysis, the lower carousel is used for placing crucibles, while the upper carousel is used for placing crucible lids. The TGA et500 Instrument utilises a pneumatic carousel mechanism for accurate crucible placement. The movement of the carousel from one crucible position to another is motorised, and the up and down mechanism of the carousel is controlled pneumatically. The carousel is made of special materials that are not susceptible to warping under high-temperature stress.

TGA et500 key features

- | Dual Carousel design
- | Analysis of up to 19 samples
- | Fully Automatic analysis
- | Samples: Organic, Inorganic & Synthetic
- | Parameters: Moisture, Volatiles, Ash, LOI & Fixed Carbon
- | Automatic placement & removal of crucible lids

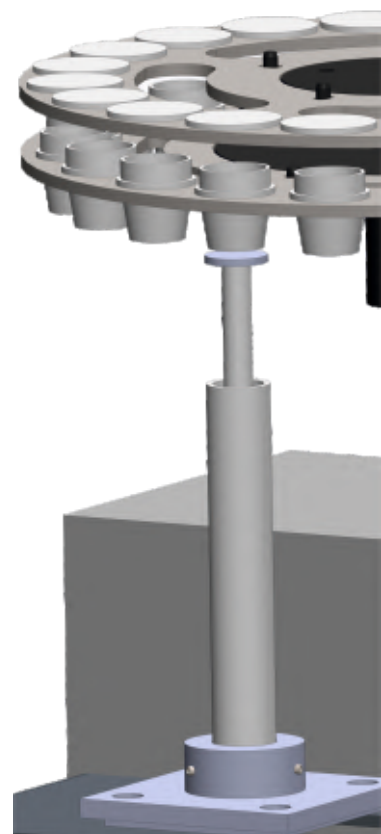

Precise Temperature Regulation

- | Best-in-class temperature setpoint control is achieved through the use of four thermocouples
- | The first thermocouple is used to detect the upper furnace temperature, while the second is used for lower furnace temperature detection. The third thermocouple is employed for real-time temperature measurement of the sample and, finally, the fourth thermocouple provides temperature cross-verification and temperature calibration functionality

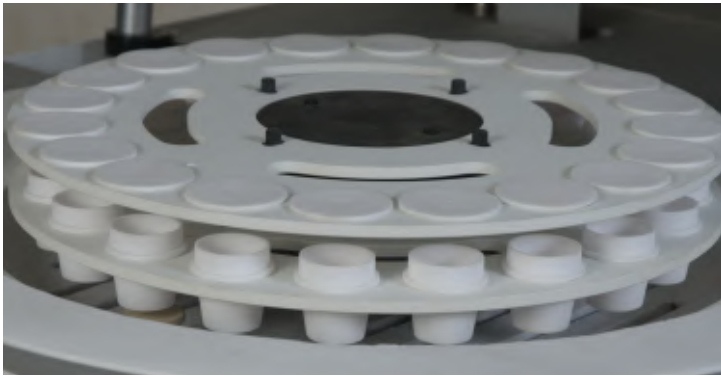

Crucible lids open



Weighing with crucible lids open

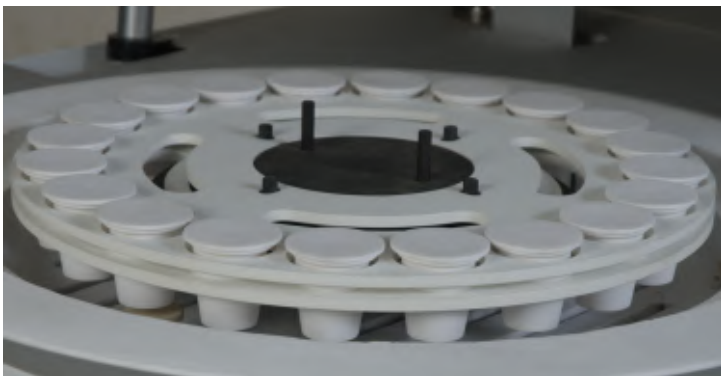

Crucible lids closed

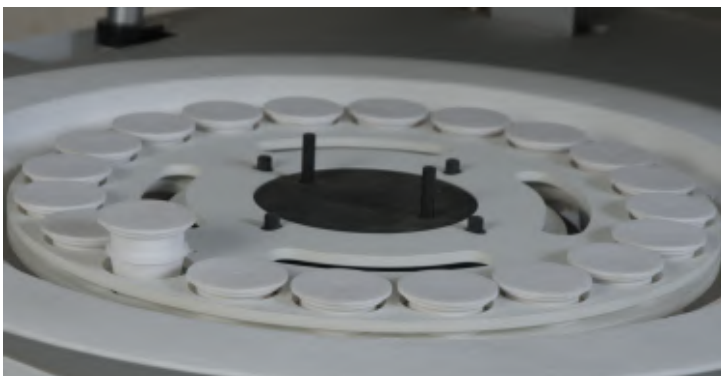

Weighing with crucible lids closed

| TGA et500 employs two carousels, each built with high strength and corrosion-resistant materials. One carousel is designated for crucibles, while the other is designated for crucible lids

| The carousels are constructed using a unique material that exhibits exceptional resistance to warping when exposed to elevated levels of thermal stress

| The second carousel enables the automated placement and removal of crucible lids within the furnace, eliminating the need to open the furnace lid

| The dual carousel design offers enhanced precision in the measurement of volatile matter along with automated functionality, thereby preventing any potential sample oxidation

| Automatic crucible management removes the risk of potential burns to the operator when exposed to elevated temperatures, and removes the possibility of the operator inadvertently dropping the crucible lids into the furnace







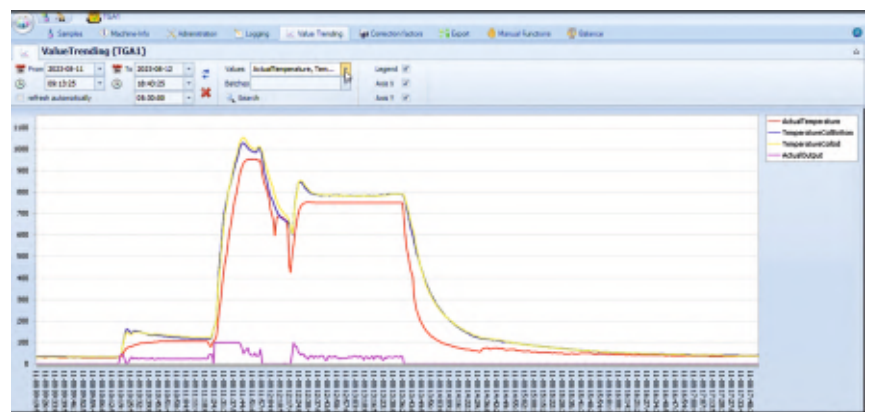
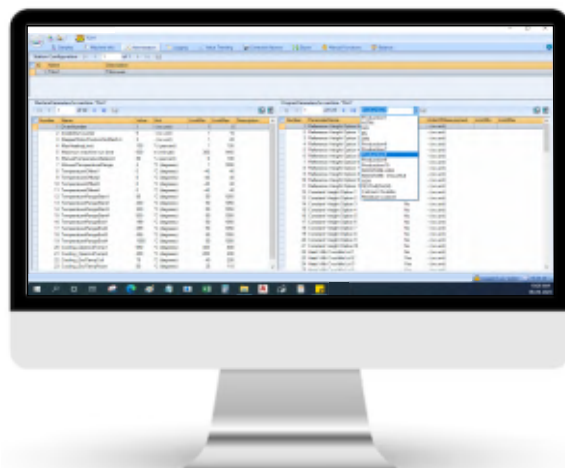
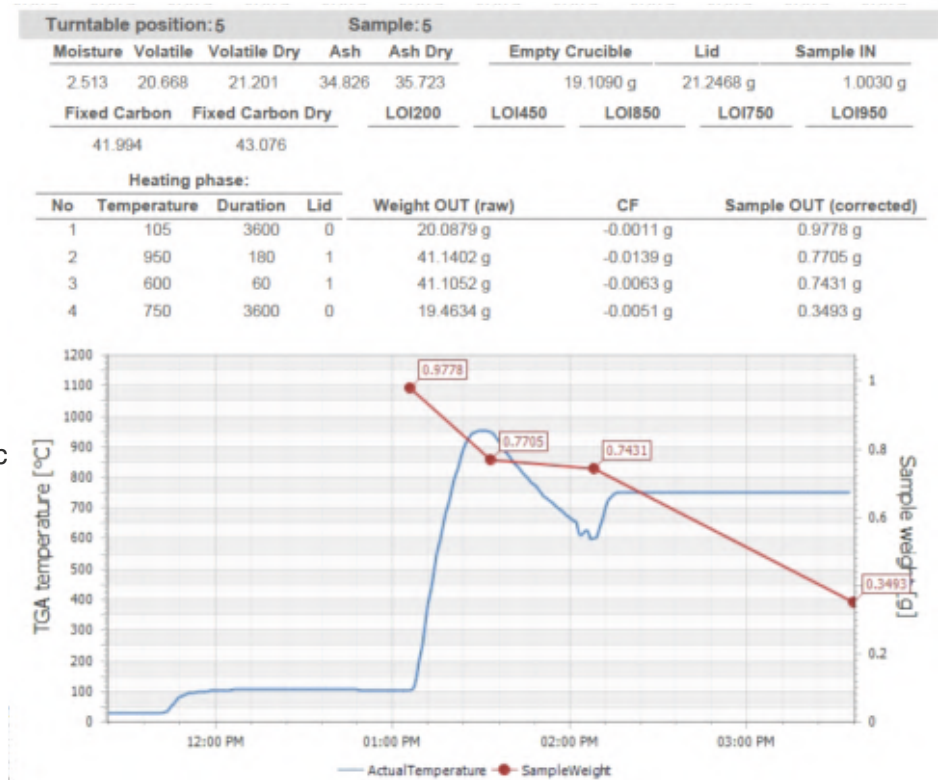
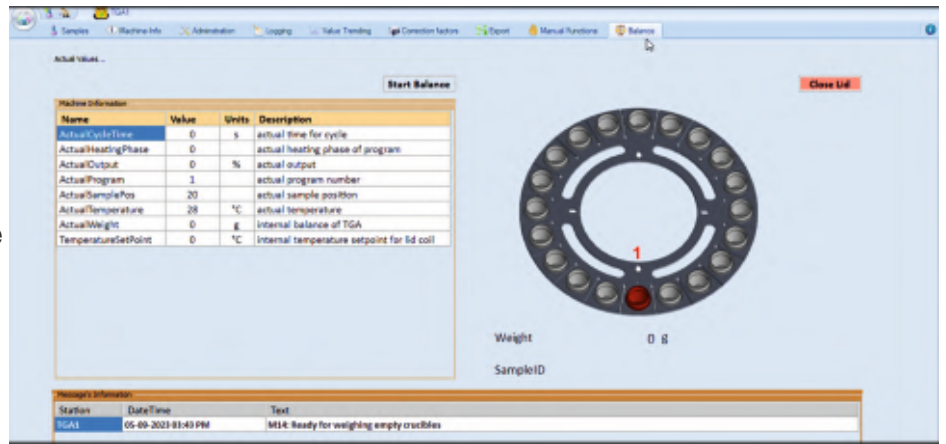

Software Features

- The user-friendly software enables complete control of the analyser through a graphical interface. It provides visual representations of temperature versus weight loss measurements, as well as real-time displays of parameters such as furnace temperature, sample status, and remaining time
- The software provides flexible method settings, including temperature ramps, set points, programmable gas flows, and options for placing or removing crucible lids, as well as criteria for maintaining mass constancy. These settings cater to various customer applications such as moisture determination, volatile matter determination, Loss on Ignition (LOI) determination, and ash determination
- TGA et250 & TGA et500 come pre-programmed with 10 in-built standard methods for analysing coal samples in accordance with ASTM and ISO standards. Additionally, the software enables users to configure up to 16 custom methods based on their specific requirements
- The software offers a versatile sample login and loading procedure, accompanied by real-time graphical representations of analysis data



Test Methods

Elite Thermal's TGA et250 & TGA et500 complies with the following test methods.

	Standard	Title of the standard
Coal & Coke 	ASTM D7582-15	Standard Test Methods for Proximate Analysis of Coal and Coke by Macro Thermo Gravimetric Analysis.
	ASTM D5142	Standard Test Methods for Proximate Analysis of the Analysis Sample of Coal and Coke by Instrumental Procedures.
Mineral Ores 	ISO 562	Hard Coal and Coke - Determination of volatile matter.
	ASTM D7348	Standard Test Methods for Loss on Ignition (LOI) of Solid Combustion Residues.
	DIN 51718	Testing of solid fuels - Determination of the water content and the moisture of analysis sample.
Gypsum & Hydrated lime 	ASTM E1755	Standard Test Method for Ash in Biomass.
	DIN 51719	Determination of ash in solid mineral fuels.
	ISO11722	Solid mineral fuels - Hard coal - Determination of moisture in the general analysis test sample by drying in nitrogen.
Soil & Fertiliser 	ISO1171	Solid mineral fuels - Determination of Ash.
	EN 15148	Solid biofuels - Determination of the content of volatile matter.
	ISO/TR 18230	Determination of Loss on Ignition - Non oxidized ores.
Cement & Building Materials 	ASTM C114	Determination of Loss on Ignition of Hydraulic Cement.
	ISO 806	Aluminum Oxide Primarily used for the product of aluminium - Determination of loss of mass at 300°C and 1000°C.
Food & Feed 	EN 14775	Solid biofuels - Determination of Ash content.
	AS1038	Proximate analysis & Testing.
	BS1016	Proximate analysis.

Technical Specifications

Specifications	TGA et250	TGA et500
Temperature Range	Programmable from ambient to 1100°C	Programmable from ambient to 1100°C
Temperature Control Precision	±2 deg C (or) ±2% of set point temperature	±2 deg C (or) ±2% of set point temperature
Temperature Stability	±2 deg C (or) ±2% of set point temperature	±2 deg C (or) ±2% of set point temperature
Ramp Rate	Programmable from 10°C /minute to 50°C /minute	Programmable from 10°C /minute to 50°C /minute
Balance	Integrated Balance	Integrated Balance
Balance Resolution	0.0001g (0.1mg)	0.0001g (0.1mg)
Balance Readability	0.0001g (0.1mg)	0.0001g (0.1mg)
Weight Loss	0 to 100%	0 to 100%
Sample Size	up to 10 grams based on the sample type and its characteristics	up to 10 grams based on the sample type and its characteristics
Number of Samples	19 Samples +1 Reference	19 Samples +1 Reference
Number of Carousels	One for crucibles and crucible lids	Two (one for crucibles and the other for crucible lids)
Carousel Material	Metal or Ceramic	Metal or Ceramic
Weighing Precision	0.02% RSD (on inert samples)	0.02% RSD (on inert samples)
Electrical Power Requirements	230V (± 10%) / single phase / 50/60Hz / 32A	230V (± 10%) / single phase / 50/60Hz / 32A
Computer	230V (± 10%) / single phase / 50/60Hz / 2A	230V (± 10%) / single phase / 50/60Hz / 2A

Ash Fusion Determinator

- a step towards an improved Ash Fusibility Analysis

When any fuel is burned, an incombustible waste material is produced, commonly known as ash.

As the burning process progresses, the temperature of the combustion environment reaches a point where the ash particles start to melt.

This melting occurs because the heat energy breaks down the chemical bonds holding the ash particles together, causing them to transition from a solid state to a liquid state. Once the ash has melted, it begins to undergo a cooling process. As the melted ash cools down, it solidifies and forms clinkers.

Clinkers are hard, stony residues composed of the solidified ash particles, which frequently stick to the inner surfaces of the combustion chamber.

Clinker build-up poses challenges for large coal furnaces, often requiring furnace closure for maintenance. Understanding the fusibility properties of coal ash facilitates temperature management to mitigate clinker formation.

The Ash Fusion Temperature serves as an indicator of the point at which the ash undergoes a transition from a solid to a liquid state through melting. This temperature is a crucial parameter in the planning and execution of gasification systems.

Ash Fusion Determinator

EATC16 Series

Elite Thermal's EATC16 Series Ash Fusion Determinator for four critical temperatures:

- | Initial Deformation Temperature (IDT)
- | Softening Temperature (ST)
- | Hemisphere Temperature (HT)
- | Fluid Temperature (FT)

EATC16 Series key features

- | Bench-mounted Ash Fusion Determinators
- | Maximum Furnace Temperature: 1600°C
- | Types of samples: Coal ash, coke ash, biomass ash, refuse-derived (RDF) ash, and solid biofuel ash
- | Analysis parameters: Fusion points (IDT, ST, HT, and FT) of ash samples
- | Type of analysis: Manual in EATC16 Manual Model
Automatic in EATC16 & EATC16^{plus}
- | Precisely controlled high-temperature horizontal resistance furnace
- | Furnace is capable of operating in both oxidising and reducing atmospheres
- | Programmable temperature ramp rates
- | Up to 6 samples can be analysed simultaneously for each batch
- | Capture images of the samples at every 1°C increase temperature in EATC16 & EATC16^{plus}
- | Grid feature for accurate comparison of sample height and width in EATC16 & EATC16^{plus}
- | Quick cooling facilitated by low thermal mass insulation allows for the completion of multiple tests within a day
- | Automatic gas switching between oxidizing and reducing gases based on selected test conditions (Available in EATC16^{plus})

EATC16 Manual

- | A high-resolution camera with a manually adjustable lens mounted on a suitable arm is used to view the samples being tested
- | This setup allows for easy movement away from the furnace to access the work tube
- | The video image is sent to a high-end computer system where it is recorded and displayed in a specially created logging program
- | Accepts specimen shapes in accordance with ASTM, ISO, and DIN standards, including cylinder, pyramid, upright pyramid, and truncated pyramid

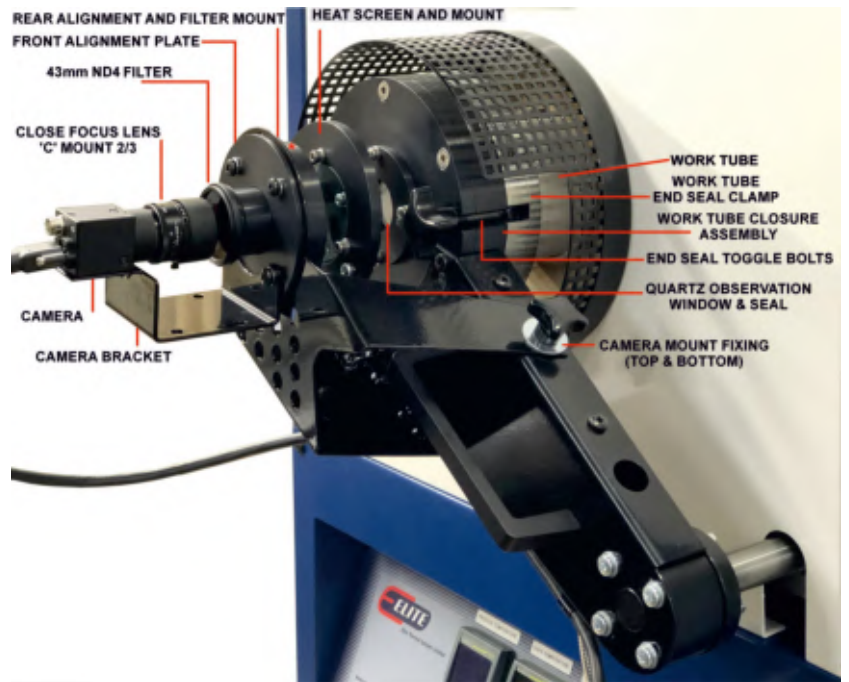

EATC16 & EATC16plus

- | A high-resolution camera is mounted on an arm on the EATC16 and EATC16plus for real-time monitoring of the entire test process
- | The camera in EATC16 and EATC16plus allows viewing a complete video of the analysis
- | Adjustable grid scale for each test specimen
- | Grid overlay feature for accurate comparison of sample height and width
- | Accepts specimen shapes as per standards
- | Direct specimen capturing without using mirrors for accurate and precise fusion temperature measurements
- | Continuous recording of sample images
- | Real time monitoring of the samples and test process
- | Auto identification of fusion temperatures (IDT, ST, HT & FT)



EATC16 Manual

- | EATC16 Manual Ash Fusion Determinator with Manual interpretation software, with 2 flow meters
- | Gas inlets for reducing, oxidising & purge gases
- | Alarms are fitted to indicate when supply gas pressures are running low
- | The furnace has three gas connections on the rear of the furnace: Individual ports for CO₂, H₂, and one for Purge gas
- | Pressure switches are fitted to all three gas lines, purge gas, CO₂ gas and H₂ gas



EATC16 Manual



EATC16

EATC16

- | EATC16 Ash Fusion Determinator with automatic interpretation software
- | Up to 6 samples can be analysed simultaneously for each batch
- | Automatic and continuous recording of images
- | Capture images of the samples at every 1°C increase in temperature
- | The furnace has three gas connections on the rear side of the furnace: Individual ports for CO₂, H₂, and one for Purge gas
- | EATC16 Ash Fusion Determinator used 2 flow meters for oxidising, reducing and purge gases
- | A grid overlay feature is provided within the software for each sample
- | The grids are positioned to identify the samples for automatic analysis or are used to assist manual analysis
- | They ensure accurate comparison of the height and width of the sample melt points
- | The position and scale of each grid is easily adjustable

EATC16plus

- | Similar to EATC16, EATC16plus uses the same software
- | The furnace has five gas connections on the rear side of the furnace: Individual ports for CO, CO₂, H₂, and Air and one for Purge gas
- | A significant advantage of the EATC16plus is its four flow meters, which allow automatic switching between oxidising and reducing gases in response to selected test conditions
- | EATC16plus includes separate gas inlets for CO, CO₂, H₂, N₂ and Air



EATC16plus

General Specifications	EATC16 <i>plus</i>	EATC16	EATC16 Manual
Ash Fusibility Determination	Automatic	Automatic	Manual
Fusion Points	IDT (Initial deformation Temperature), ST (Softening/Sphere Temperature), HT (Hemisphere Temperature) & FT (Fluid/Flow Temperature)		
Test Method	ASTM D 1857; ASTM E953; BS ISO 540; BS ISO 21404, CEN/TS 15370-1; CEN/TR 15404:2010. DIN 51730; ISO 540; ISO 21404		
Capable to Analyse	Cube/Cylinder, Pyramids/Cone, Upright cone/Upright Pyramid and Truncated cone/Truncated Pyramid.		
Sample shape identification	Automatic - Cube/Cylinder, Pyramids/Cone, Upright cone/Upright Pyramid and Truncated cone/Truncated Pyramid.	Manual - Cube/Cylinder, Pyramids/Cone, Upright cone/Upright Pyramid and Truncated cone / Truncated Pyramid.	
Analysis atmosphere	Oxidizing Atmosphere/Reducing atmosphere		
Furnace Specifications			
Temperature range	up to 1600°C		
Temperature Ramp Rate	programmable 1°C to 12°C per minute		
Temperature precision	±5°C as per standard test methods at 1064°C (99.98% pure gold wire sample melting point)		
Number of heating elements	6 nos - High temperature resistance type heating elements		
Working tube dimensions	90 x 76 x 675mm		
Material of construction of working tube	High grade RCA Alumina work tube		
Analysis Time	4 hours typical cycle time (depending ramp rate and temperature range)		
Stand by Temperature			
Stand by Temperature	Room Temperature	Room Temperature	815°C
Ventilation			
Ventilation	Forced air ventilation		
Exhaust	Pipe to be vented into a separate fume hood		
CO Monitor (Optional on request)	Integrated CO monitor with auditory alarm, Gas flow shut off on alarm. This is factory installed option. Need to order along with main EATC16 Instrument.		NOT AVAILABLE
Gas requirements			
Gas requirements	Integrated four gas flow meters to enable automatic switching of the gases based on the selected test conditions, such as oxidation or reduction.	Integrated two gas flow meters to enable automatic switching of the gases based on the selected test conditions, such as oxidation or reduction.	Integrated two gas flow meters for manual switching of the gases based on the selected test conditions, such as oxidation or reduction.
	Note: At the time of ordering, the user must specify the required gases for their analysis, choosing either CO ₂ /H ₂ or CO/CO ₂ for the reduction mode.		
Electrical requirements			
	380 – 415 V, 50/60 Hz two phase 25 A		
Environmental Conditions			
Operating Condition	15°C to 35°C		
Relative Humidity	20% to 80%, non-condensing.		
EATC16 External Dimensions			
Dimensions- H x W x D in mm	770mm x 660mm x 1010mm	700mm x 505mm x 970mm	700mm x 505mm x 970mm
Weight in kg	Approx. 160kgs	Approx. 95kgs	Approx. 90kgs
PC specifications			
Required PC Specifications	Processor: i3 or i5, RAM: Minimum 4GB, Memory: 512GB HDD or SSD PCI slots: Minimum 1, PCIe slots: Minimum 1, RS 232 Ports: 2 OS: Windows XP or higher		Processor: i3 or i5, RAM: Minimum 4GB, Memory: 512GB HDD or SSD PCIe slots: Minimum 1, RS 232 Ports: 1, OS: Windows XP or higher

Ash Fusion Determinator (High Temperature Model)

EATC17

Elite Thermal's Ash Fusion Determinator, EATC17 is the high-temperature floor-mount model, which works similarly to the EATC16*plus*, but for samples which fuse at higher temperatures. A maximum temperature of 1700°C can be achieved using heating elements consisting of molybdenum disilicide. The results obtained are similar for both EATC17 and EATC16*plus* analysers.



Front view of camera arm without camera



Camera arrangement



Control panel

Test Standards

Ash Material	Test standard	Reducing Gas	Oxidizing Gas
Coal & Coke Ash	ASTM D 1857	CO-CO ₂ Ratio: 60% CO - 40±5 % CO ₂ , N ₂ for purging	Air
Coal & Coke Ash	BS ISO 540	CO-CO ₂ Ratio: 55% to 65% CO - 35% to 45% CO ₂ , N ₂ for purging H ₂ - CO ₂ Ratio: 45% to 55% H ₂ - 45% to 55% CO ₂ , N ₂ for purging	Air or CO ₂
Fusibility Of Fuel Ash	DIN 51730	CO-CO ₂ Ratio: 55% to 65% CO-35% to 45% CO ₂ , N ₂ for purging H ₂ - CO ₂ Ratio: 45% to 55% H ₂ - 45% to 55% CO ₂ , N ₂ for purging	Air
RDF Ash	ASTM E953	CO-CO ₂ Ratio: 60% CO - 40+/-5 % CO ₂ , N ₂ for purging	Air or O ₂ or CO ₂
Solid Recovered Fuels	CEN/TR 15404:2010	CO-CO ₂ Ratio: 55% to 65% CO - 35% to 45% CO ₂ , N ₂ for purging	Air or CO ₂
Solid Biofuels	ISO 21404	CO-CO ₂ Ratio: 55% to 65% CO-35% to 45% CO ₂ , N ₂ for purging H ₂ - CO ₂ Ratio: 45% to 55% H ₂ - 45% to 55% CO ₂ , N ₂ for purging	Air or CO ₂

Technical Specifications

Specifications	EATC17
Temperature Range	Up to 1700°C
Temperature Ramp Rate	Programmable up to 12°C/minute
Work Tube dimensions	86 x 76 x 675mm
Heating Elements	High temperature resistance type heating elements - 4 nos
Maximum Sample Load	6 Samples per analysis
Conforms to Standards	ASTM D 1857; ASTM E953; BS ISO 540; BS ISO 21404, CEN/TS 15370-1; CEN/TR 15404:2010. DIN 51730; ISO 540; ISO 21404.
Ash Fusibility Determination	Automatic determination of IDT, ST, HT, FT fusion temperatures
Analysis Time	4 hours typical cycle time (depending ramp rate and temperature range)
Gas Requirements Purge Oxidizing Reducing Ventilation	N ₂ (or) CO ₂ Air (or) CO ₂ (or) O ₂ CO + CO ₂ or H ₂ + CO ₂ Forced air ventilation
Gas flow	Integrated two gas flow meters for manual switching of the gases based on the selected test conditions, such as oxidation or reduction. The furnace has three gas connections on the rear of the furnace: Individual ports for CO ₂ , H ₂ , and one for Purge gas. Note: At the time of ordering, the user must specify the required gases for their analysis, choosing either CO ₂ /H ₂ or CO/CO ₂ for the reduction mode.
Exhaust	Pipe to be vented into a separate fume hood
Power supply	380 – 415 V, 50/60 Hz two phase 32A
Environment Conditions Operating Conditions Relative Humidity	5°C – 40°C 20% to 80% (Non-Condensating)
Required PC Specifications	Intel core i5 or above, 256GB SSD, 16GB RAM, Windows OS

Multi Tube/Pre Heat Furnace

TMTH14

Multi Tube/Pre Heat Furnaces with multiple tubes are versatile, energy-efficient, and especially suitable for baking fluxes and crucibles. The baking process reduces contaminants and improves measurement accuracy and precision.

The baking process is simple and easy to implement and it can effectively remove impurities and moisture adsorbed by crucibles, samples and fluxes during storage, reducing the blank value and stabilizing the measured value, improving accuracy and precision of measurement.

For consistent and reliable results in various analytical applications, the design of TMTH14 series Multi Tube/Pre Heat Furnaces focuses on precise temperature control and uniform heating.

The TMTH14 series Multi Tube/Pre Heat Furnace offers greater efficiency because it allows the operator to burn off crucibles simultaneously in four combustion tubes, which increases productivity up to four times.

Standard Features

Maximum Furnace Temperature: 1400°C

Continuous Operating Temperature: 600°C to 1350°C

- | This product is a stylish bench mounted furnace with integral controls mounted in its base, and is fitted with a shelf to store the crucibles
- | Faster heating and cooling with high quality and high efficiency insulation
- | Equipped with high-quality heating elements designed to achieve fast ramp rates
- | Inner diameter of tube is 50mm for crucibles, samples and fluxes baking
- | R type thermocouple for precise temperature measurement
- | High end microprocessor PID temperature controller
- | Easy to use temperature controller clearly displays set temperature or actual temperature
- | This furnace design requires four separate work tubes, made from a grade suitable for the maximum temperature rating of 1400°C
- | The combustion tubes are designed with both ends open, allowing for easy manual loading of crucibles from the front and unloading from the rear
- | Work tubes are not included with the furnace and must be purchased separately, as they are essential accessories
- | An independent over-temperature controller is fitted as standard
- | Power Supply: 230V - 1 Phase -50Hz with N & E



TMTH14-4

Note: For all multi-tube/pre heat furnaces, Elite Thermal Systems manufactures custom-built solutions. Please contact us with your specific requirements.



Innovative solutions for your Applications

- | Aerospace
- | Automotive
- | Cement Industry
- | Ceramics
- | Coal Industry
- | Education
- | Electronics
- | Finishing Industry
- | Glass
- | Materials Testing
- | Metals Industry
- | Nuclear
- | Petrochemicals
- | Quality Assurance
- | Research
- | Superconductivity



Elite Court, 6 Stuart Road, Market Harborough, Leicestershire, UK



F3, Welland Business Park, Market Harborough, UK

Elite Thermal Systems Ltd

Elite Court, 6 Stuart Road,
Market Harborough,
Leicestershire
LE16 9PQ, UK

www.elitefurnaces.com

Tel: +44 (0)1858 469834

E-mail: contact@elitefurnaces.com

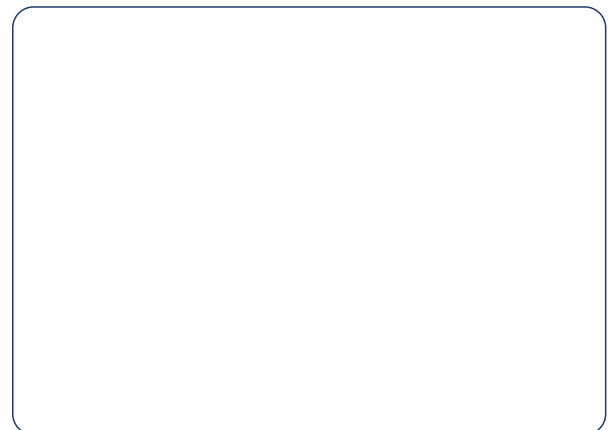

www.elitefurnaces.com

E. & O. E.

Setting the Standard for Industrial and Research Furnaces