

V-760-CFR

UV-Vis Double Monochromator Spectrophotometer

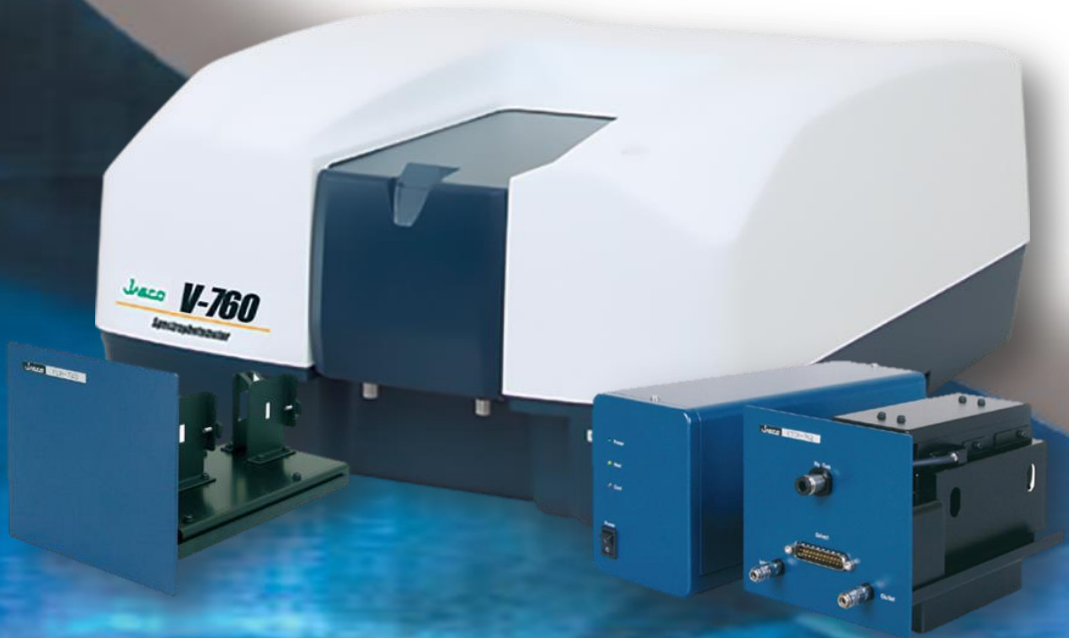

JASCO Europe is responsible for marketing, sales, service and support for all Jasco products throughout **Europe, Middle East and Africa**.



JASCO Europe S.r.l.

Via Cadorna, 1 - 23894 Cremella (LC)

Tel. +39-0399215811

Fax +39-0399215835

jasco@jasco-europe.com

www.jasco-europe.com

Follow us on:



Make the most of your investment with **JASCO Service and Support**

JASCO Service and Support agreement plans are designed for those laboratories pursuing superior productivity through the highest level of professional services.

The use of automated instrumentation is the right approach to meet today's laboratories productivity requirements, reducing analysis run times, enhancing sample throughput, and increasing analytical accuracy and precision. In this view, preventive maintenance is very important to maximize laboratory uptime and avoid unexpected expenses.

In addition to the analytical goal, proper installation and maintenance are required to achieve optimal performance. JASCO provides flexible service and support management solutions focused on your laboratory real objectives.

With its service network, JASCO is ready to maintain the perfect reliability of customer's instrumentation and minimize the laboratory down time.

- Superior productivity
- Optimized analytical performance
- Lower cost of ownership
- Extended instrument life

If your laboratory has specific Service and Support requirements, JASCO can help you with customized contract agreements. In addition, a full set of Installation Qualification (IQ), Operational Qualification (OQ), and Performance Qualification (PQ) tests are available to verify the system proper installation, operation and performance, respectively.

Get the most from your investment with **JASCO Training Courses**

JASCO Training Courses ensure maximum skill development for the best value of your laboratory. Our team of highly-experienced specialists can help your staff to get the most from your instrument reducing your analysis run time and improve performance.

Build your knowledge with JASCO Training Courses:

- Instrument and Software operation
- troubleshooting
- Maintenance
- Calibration
- Applications and Methods developments
- Operating Techniques



UV-Vis Spectrophotometer JASCO V-760-CFR

V-760-CFR is a double beam spectrophotometer with a **double grating monochromator** covering the wavelength range of **187-900 nm**. Unlike similar instruments which use a pre-monochromator and main monochromator, V-760-CFR incorporates two fully symmetrical monochromators. This unique optical design provides higher resolution with extremely low **stray light of 0.00008%** which enables measurements of highly absorbing samples and is effective for filter measurements approaching 0%T.

JASCO V-760-CFR KEY FEATURES

High photometric linearity across the whole wavelength range - The photometric linearity range is up to 6 Abs in the UV-Visible region (and up to 8 Abs in the visible). V-760-CFR offers measurement with a wide dynamic range and high-absorbance by employing optimized high-order cut-off filters, ultra high-resolution A/D converter and simplified signal processing prior to the A/D conversion.

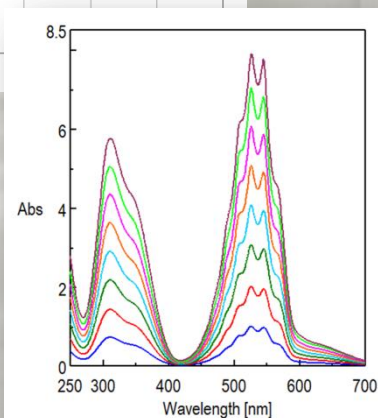
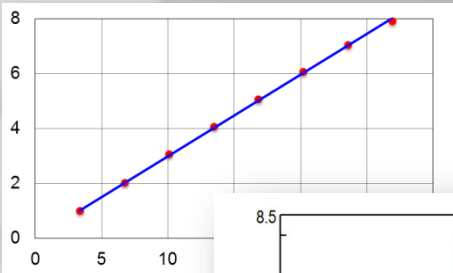

Excellent linearity up to 8 absorbance using KMnO₄ aqueous solution

Diffuse Reflectance Measurement - Diffuse reflectance measurement using the ISV-922 Integrating sphere. The graphic is a plot of the XY chromaticity in the color diagnostic application program. The integrating sphere includes a light trap which can be used to include or exclude the specular component. For measurement of dark colored materials, the dark correction function is available for highest accuracy.

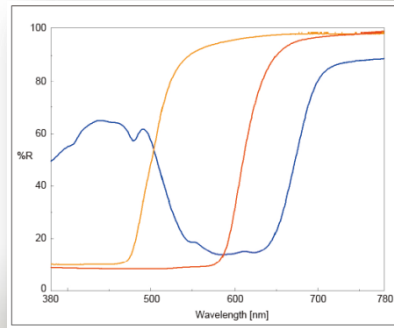

Reflectance Spectra of Powder Samples

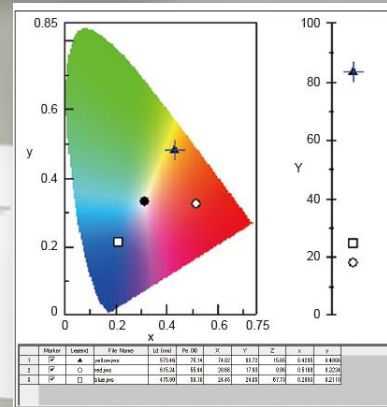

Plot View of Color Diagnosis

Measurement down to 187 nm - The lower stray light optical design enables measurement in the UV down to 187 nm without N₂ purging. The transmittance spectra of three optical materials - quartz, sapphire and BK-7 measured using the FLH-741 film holder are shown below.

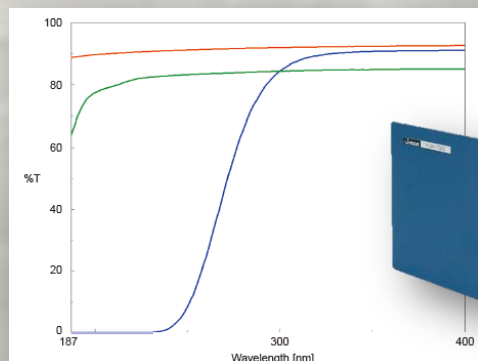

Transmission spectra of window materials in UV range

Micro Volume Measurement - The spectral bandwidth settings of V-760-CFR has 'L' Mode and 'M' Mode settings. The 'L' Mode is effective for measurement of highly absorbing samples. The 'M' Mode focuses the incident beam for accurate measurements of trace amounts of sample in a micro cell. Micro volume measurement can be made by using a cell with a 2 mm width and setting the spectral bandwidth to an M-mode slit; useful for measurement of volume limited liquid samples. One Drop accessory also allows easy volume measurement as low as 600 nL.

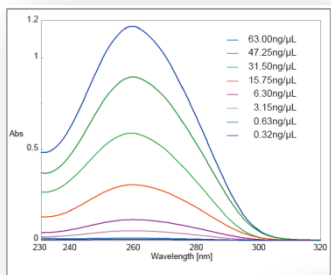

Spectra of DNA Solutions

Film thickness measurement - Film thickness measurements can be made using the SLM-907 specular reflectance accessory and integrated as standard Film Thickness measurement program. The film thickness of a food packaging film using the SLM-907 single reflection accessory is shown below.

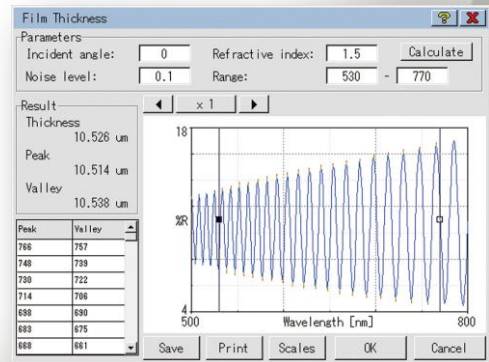

Validation - V-760-CFR provides a standard validation program. This program supports USP, EP and JP instrument qualification requirements. The program automatically performs an analysis of the instrument results based on defined acceptance criteria. Results of the validation tests can be printed or saved electronically for further review.

Step-scan measurement - A step scanning function is available for spectral measurement in all models of the V-700 Series. This function is an effective scanning mode in cases where the sample absorbance varies very rapidly. The figure below illustrates the results of the measurement of an interference filter at a wavelength range where the absorbance changes rapidly by using the V-760-CFR in the step scan mode. The range shorter than 490 nm has a strong absorbance of around 6 Abs. The significant variation between 490 and 510 nm can be measured very accurately using the step scan measurement mode.

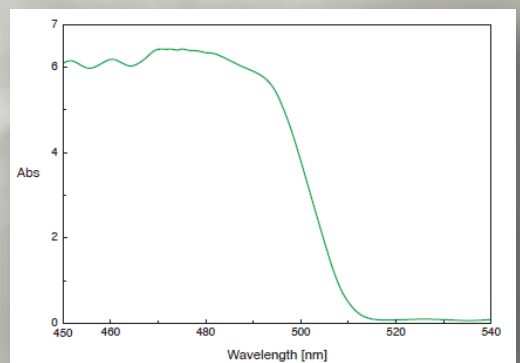

Spectra of albumen solutions

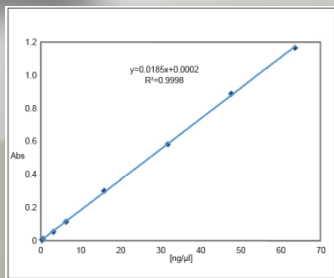

Calibration Curve of DNA Solution

Dark Correction - A Dark Correction function is standard for all models of the V-700 Series, which provides photometrically accurate measurements of highly absorbing samples.

Energy and space-saving system

- Green technology, best energy-saving in its class Switch off the light source from the measurement screen when not in use.
- Save energy and lamp life.
- All models have the most compact design requiring minimal bench space.

Daily check program - For users who requires a regular validation check; use a simple Holmium glass filter (or other standard) for daily measurement with automatic execution of procedures to easily record and track a comprehensive history of instrument performance.

Alignment-free lamp replacement - The design of the socket deuterium lamp and socket tungsten halogen lamp facilitates light source over replacement, simplifies maintenance and reduces operation error.

In the example below, single beam spectra and validation results of 4 different lamps mounted without any alignment tools.

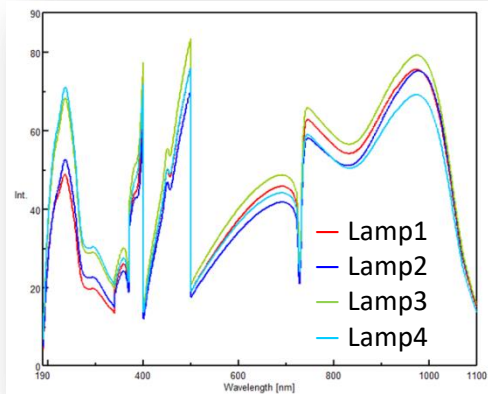

True Double-Beam spectrophotometer - All JASCO V-700 spectrophotometers are true double-beam systems, provide the best possible stability and allow reference to be measured and corrected in real time.

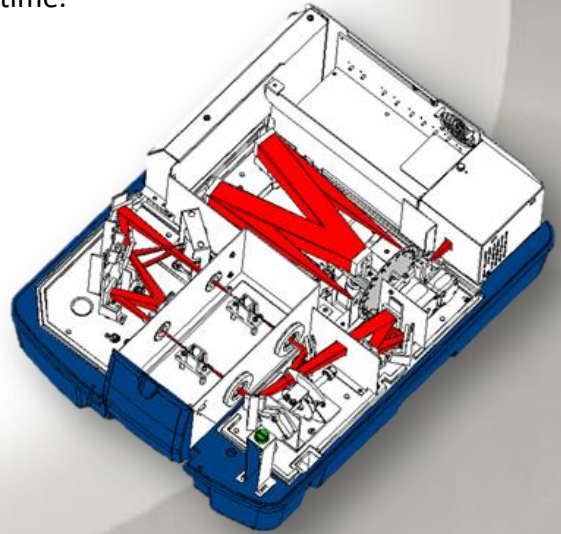

High resolution measurement - The figure illustrates the spectral measurement of benzene gas introduced into a cylindrical cell with an optical path length of 10 mm with the bandwidth set at 0.1 nm. Several sharp peaks and minute structures can be clearly observed.

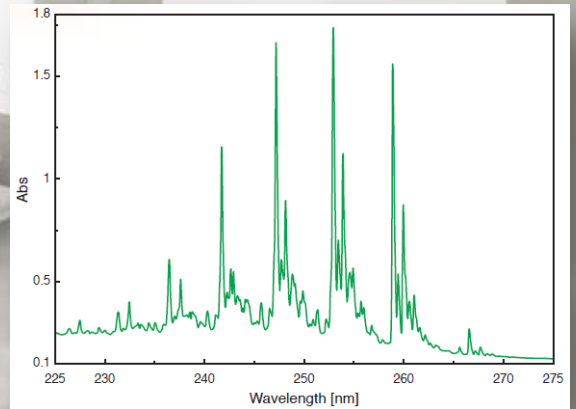

	Lamp 1	Lamp 2	Lamp 3	Lamp 4
Wavelength Accuracy	Pass	Pass	Pass	Pass
Photometric Accuracy	Pass	Pass	Pass	Pass
Noise Level	Pass	Pass	Pass	Pass
Baseline Flatness	Pass	Pass	Pass	Pass

Dual wavelength time course measurement - kinetics measurement can be performed by simultaneous dual wavelength, and the difference between dual photometric value and the ratio of dual photometric value can be plotted.

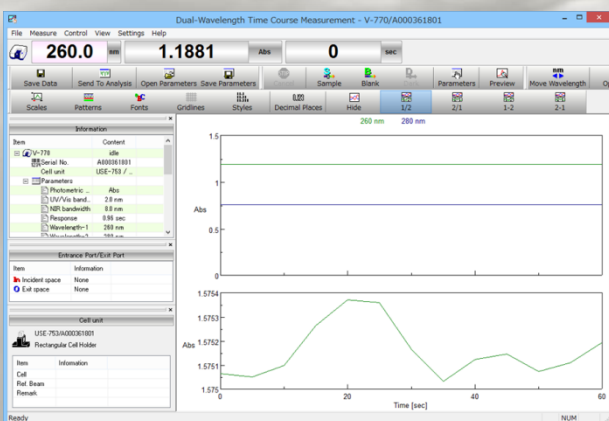

IQ accessory and IQ Start - The IQ Accessory function automatically recognizes an accessory when it is inserted into the sample compartment. When the IQ Accessory system recognizes the registered accessory, the assigned program automatically starts by using the IQ Start function.

Start Button - All models have a Start Button for immediate initiation of sample measurement. After placing a sample in the sample compartment, simply press the Start Button on the instrument to begin measurement.

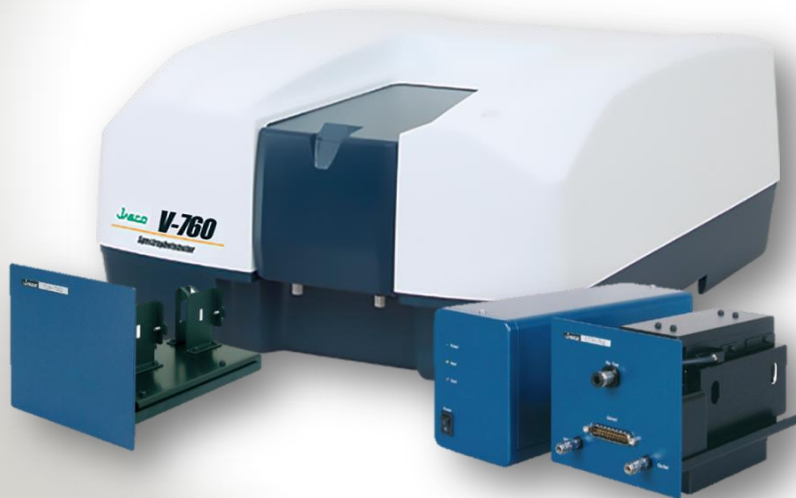

JASCO V-760-CFR Unique Features

- **Standard working range (187 to 900 nm)** and variable spectral bandwidth from **0.1 nm** enough to satisfy any requirements.
- **Double Monochromator** spectrophotometer able to achieve an outstanding **Stray Light** (0.00008%) and **Dynamic Range** (8 Abs) provide capabilities from education and routine analysis to high-end research applications.
- Diffuse reflectance measurement using **Integrating Spheres** with a light trap which can be used to include or exclude the specular component.
- The **'L' Mode** and **'M' mode spectral bandwidth** settings for measurement of highly absorbing samples or for accurate measurements of trace amounts of sample in a micro cell.
- **True Double-Beam** spectrophotometer provides the best possible stability and allows reference to be measured and correct on real time.
- **IQ Accessory function** for automatic recognition of any accessory inserted into the sample compartment.
- **Validation** and **Daily Check** programs help operator to keep the instrument always in perfect conditions assuring maximum accuracy of obtained results.
- The V-700 Series can be integrated with more than **70 accessories** and over **30 optional programs** to offer flexible configurations for a wide variety of analytical requirements.
- Cross-platform software package **Spectra Manager CFR** provides features to support laboratories for compliance with **21 CFR Part 11**.

Software JASCO SPECTRA MANAGER II

The SPECTRA MANAGER II program is a comprehensive package for capturing and processing data, eliminating the need to learn multiple software packages and offering the user a shallower learning curve. Several types of measurement data files can be viewed in a single window, and processed using a full range of data manipulation functions.

The basic package includes:

QUICK START MEASUREMENT PROGRAM - The Quick Start Measurement Program can automatically perform a series of operations as specified by a user, from measuring samples and processing data to saving and printing results, with a single click of the start button. The procedure is stored in memory for repeated use. The data processing functions include comparison of an obtained spectrum with spectra specified by a user.

SPECTRA MEASUREMENT PROGRAM - The Spectra Measurement program measures photometric values of a sample in the selected wavelength range. Abs, %T or %R are available for the vertical axis while nm, cm⁻¹, μm, and eV are available for the horizontal axis.

CANVAS PROGRAM - JASCO Canvas Program allows the user to prepare publication quality layouts of spectra, measurement parameters, text, images (BMP and WMF formats) to meet the user's own report requirements. The program also includes a set of drawing tools for professional documentation. Newly created documents can be stored as templates for routine data presentation.

VALIDATION PROGRAM - The Validation program offers assistance for verifying instrument performance to meet regulatory requirements set by GxP. The test methods are compliant with USP, EP and JP procedures. The program includes validation tests for wavelength accuracy, wavelength repeatability, photometric accuracy, photometric repeatability, resolution, resolution power, stray light, noise level, baseline stability and baseline flatness. Optional standards and tools are required for some validation tests.

QUANTITATIVE ANALYSIS PROGRAM - The quantitative measurement package consists of two programs; a calibration curve creation program and a quantitative measurement program. The program provides three types of baseline correction methods and eight types of calibration curves. A function for providing a pass/fail judgement for the obtained values is included.

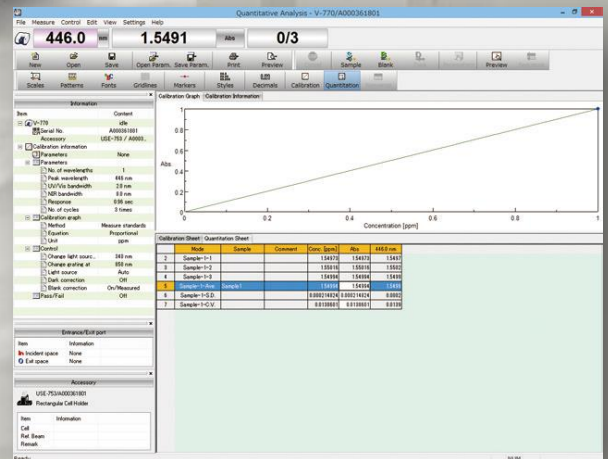
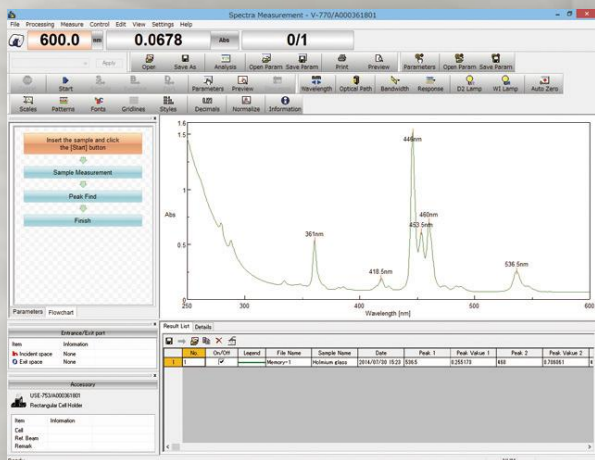

Software JASCO SPECTRA MANAGER II

FIXED WAVELENGTH PROGRAM - The Fixed Wavelength measurement program measures the photometric values of up to eight multiple wavelengths. A 'cycle number' and 'wait time' are selectable, and the mean, standard deviation and C.V. value for each wavelength are displayed after completion of each cycle of sample measurements.

SPECTRUM PREVIEW FUNCTION - The spectrum preview function allows a user to monitor changes to a spectrum by varying parameters in real-time. A spectrum can be rapidly obtained using the maximum scanning speed available. This function allows verification of the optimum set of instrument parameters and to check sample conditions before actual measurements.

TIME COURSE PROGRAM - The Time Course measurement program measures the changes of a sample's photometric value over time at a fixed wavelength and with a defined interval. For the time course measurement, the V-760-CFR can obtain data at a minimum interval of 0.05 sec. Parallel time course measurements while controlling the cell positions of a cell changer are also possible.

SPECTRA ANALYSIS PROGRAM - The spectra analysis program includes all typical data analysis and data manipulation functions.

Furthermore, the film thickness measurement, color analysis, and the enzyme activity calculation programs are provided as standard.

Data manipulation functions

- Spectral manipulations (zoom in, zoom out, rescale)
- Overlay
- Arithmetic operations
- Spectral Subtraction
- Derivatives
- Peak detection and processing - Find, Height, Area, FWHH
- Smoothing
- FFT Filter
- Deconvolution
- Baseline correction
- Unit conversion

AUTOMATIC SETUP - The response time is automatically determined depending on the selected bandwidth and scan speed so that the spectrum profile does not become broad. The data interval is also automatically determined depending on the selected bandwidth.

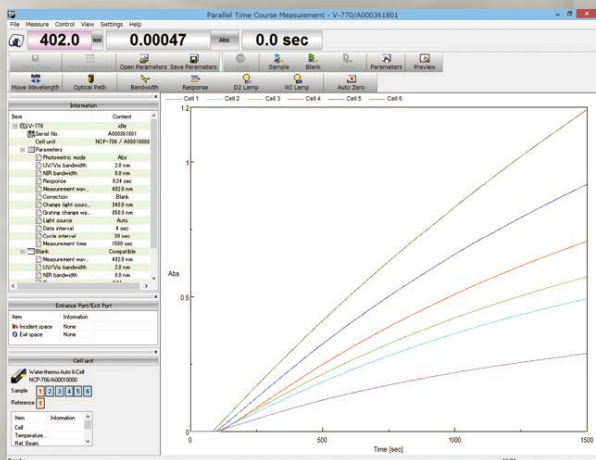

Software JASCO SPECTRA MANAGER II - CFR

Spectra Manager CFR provides features to support laboratories for compliance with **21 CFR Part 11**. A choice of complete pull-down task menus, user-friendly icons, and easily accessible pop-up menus enables new users to manage security information, control user access, and record audit trails.

The package includes:

- Access control for secure systems by user ID and password
- Audit trail function with time-stamp for records tracking
- Three levels of electronic signatures for record integrity

Easy-to-use

Startup window lists available resources, such as instruments, measurement and application programs.

User registration

All users who use Spectra Manager CFR must be registered. When registered, the user must be assigned specific access levels for administrative rights and access to control and analysis programs.

New User

Username:

Full Name:

Division:

Access Level:

Password:

Confirm Password:

OK Cancel

System policy

Password expiration, the minimum number of characters and timeout for password entry can be set by authorized managers.

Access rights control

User access to the Spectra Manager CFR requires a Username and Password.

Security management

All of the security management functions of Spectra Manager CFR are accessed through the Administrative Tools interface.

Workgroup registration

Users who perform measurements and analyses must be registered in a workgroup. Within a workgroup, users are granted access as either a “Manager”, “Analyst”, or “Operator”, with authorities to modify instrument and analysis settings. Individual users are only able to execute procedures that are allowed by their assigned access level.

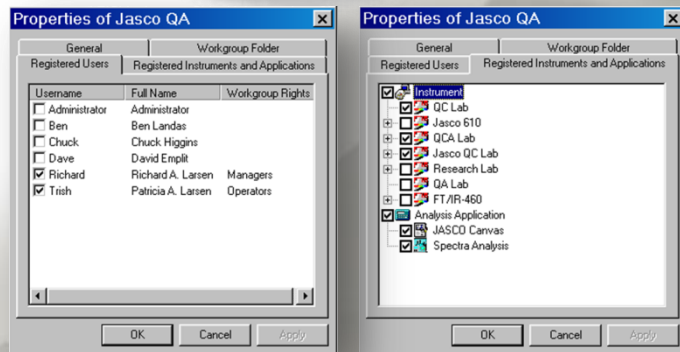

Audit trails

The system and application history are automatically recorded. Audit trails are assigned to every data file, recording data manipulations on the spectral data. Audit trails are also applied to instrument parameters, Canvas templates or documents and analysis methods.

Category	Date and Time	Description	Extra Information	User	Initial group	Instrument	Application
Information	11/05/2003 2:17:05 PM	Disconnection		Richard	Jasco QC	QCA Lab	
Instrument	11/05/2003 2:17:50 PM	Starting up Analysis Application		Trish	Jasco QC	JASCO Canvas	
Information	11/05/2003 2:19:09 PM	Open Data	C:\Aik\QC\template\RALDGH\65.pf	Trish	Jasco QC	JASCO Canvas	
Information	11/05/2003 2:19:29 PM	Starting up Analysis Application		Richard	Jasco QC	JASCO Canvas	
Information	11/05/2003 2:19:29 PM	Open Data	C:\Aik\QC\template\RALDGH\65.pf	Richard	Jasco QC	JASCO Canvas	
Information	11/05/2003 2:20:29 PM	Quit Analysis Application		Richard	Jasco QC	JASCO Canvas	
Information	11/05/2003 2:20:59 PM	Starting up Analysis Application		Richard	Jasco QC	Spectra Analysis	
Information	11/05/2003 2:20:59 PM	Open Data	C:\Aik\QC\QCA\637.pf	Richard	Jasco QC	Spectra Analysis	
Information	11/05/2003 2:21:09 PM	Connection		Richard	Jasco QC	QCA Lab	
Information	11/05/2003 2:21:09 PM	Starting up Measurement Application		Richard	Jasco QC	QCA Lab	Spectra Measurement
Information	11/05/2003 2:21:09 PM	Open Measurement Conditions	C:\Aik\QC\Jasco\QD\3.pf	Richard	Jasco QC	QCA Lab	Spectra Measurement
Information	11/05/2003 2:28:55 PM	Save Measurement Conditions		Richard	Jasco QC	QCA Lab	Spectra Measurement
Information	11/05/2003 2:28:59 PM	Edit Measurement Conditions		Richard	Jasco QC	QCA Lab	Spectra Measurement
Information	11/05/2003 2:28:16 PM	Starting Measurement	Background	Richard	Jasco QC	QCA Lab	Spectra Measurement
Information	11/05/2003 2:28:12 PM	Measurement ended		Richard	Jasco QC	QCA Lab	Spectra Measurement
Information	11/05/2003 2:28:23 PM	Starting Measurement	Sample	Richard	Jasco QC	QCA Lab	Spectra Measurement
Information	11/05/2003 2:28:34 PM	Save Data	C:\Aik\QC\QCA\638.pf	Richard	Jasco QC	QCA Lab	Spectra Measurement
Information	11/05/2003 2:28:35 PM	Measurement ended	Sample	Richard	Jasco QC	QCA Lab	Spectra Measurement
Information	11/05/2003 2:28:29 PM	Open Data	C:\Aik\QC\QCA\614.pf	Richard	Jasco QC	Spectra Analysis	
Information	11/05/2003 2:33:03 PM	Open Data	C:\Aik\QC\QCA\613.pf	Richard	Jasco QC	Spectra Analysis	
Information	11/05/2003 2:33:15 PM	Open Data	C:\Aik\QC\QCA\615.pf	Richard	Jasco QC	Spectra Analysis	
Information	11/05/2003 2:40:29 PM	Quit Analysis Application		Richard	Jasco QC	QCA Lab	Spectra Analysis
Information	11/05/2003 2:40:42 PM	Disconnection		Richard	Jasco QC	QCA Lab	Spectra Measurement

Electronic signatures

Three levels of electronic signatures, “Creation”, “Review” and “Approval” are available. Electronic signatures are applied to spectral data files, Canvas templates or documents, instrument parameters and analysis methods.

Optical System	<ul style="list-style-type: none"> • Czerny-Turner mount • Double Monochromator • True Double-Beam (Sample & Reference)
Light Source	Deuterium & Halogen lamps with automatic switching
Detector	Photomultiplier tube
Wavelength Range	187 – 900 nm
Wavelength Accuracy	± 0.1 at 656.1 nm
Wavelength Repeatability	± 0.05 nm
Scanning Speed	10 to 4,000 nm/min (up to 8,000 in preview mode)
Slew Speed	12,000 nm/min
Spectral bandwidth	0.1, 0.2, 0.5, 1, 2, 5, 10 nm L2, L5, L10 nm - M1, M2 nm
Photometric Range (guaranteed on the whole spectral range)	-4 + 6 Abs
Maximum Photometric Range	-8 + 8 Abs (KMnO ₄ aqueous solution)
Photometric Accuracy	±0.0015 Abs (0 to 0.5 Abs) ±0.0025 Abs (0.5 to 1 Abs) ±0.3 %T Tested with NIST SRM 930
Stray Light	1 % (198 nm KCl 12 g/L) 0.00008 % (220 nm NaI 10 g/L) 0.00008 % (340 nm and 370 nm NaNO ₂ 50 g/L)
Baseline stability	±0.0003 Abs/hour
Baseline flatness	±0.0003 Abs
RMS noise	0.00003 Abs (0 Abs, 500 nm, 60 sec)
Communication	USB
Automatic Accessories Recognition	YES
Software	Spectra Manager II including the following programs: <ul style="list-style-type: none"> • Spectra Measurement • Quantitative analysis • Fixed Wavelength • Dual Wavelength Time Course Measurement • Quick Start Measurement • Canvas • Validation & Daily Check • Spectrum Preview • Film Thickness • Color • Enzyme Activity Calculation
Dimensions and weight	460(W)x602(D)x268(H) mm – 29 kg
Power requirements	150VA

Software & Sampling Accessories

V-760-CFR UV-Vis Spectrophotometer



JASCO

Spectra Manager Ver. 2



Sampling Accessories

V-700 Series can be integrated with a complement of more than 70 accessories to offer flexible configurations for a wide variety of analytical requirements.

Experimental capabilities range from simple educational applications and routine daily use, to specific applications for advanced biochemical and semiconductor research.

The range of accessories include various types of cell holders for liquid samples and options for a wide variety of solid samples.

LSE-701 - Long path cell holder



Specifications

Sample Cell	Rectangular cell pathlength 10, 20, 50 or 100 mm
Reference Cell	Rectangular cell pathlength 10, 20, 50 or 100 mm
Capacity	1 sample and 1 reference cell
Temperature	Ambient

FSE-702 - 4-position manual long path cell changer



Specifications

Sample Cell	Rectangular cell pathlength 10, 20, 50 or 100 mm
Reference Cell	Rectangular cell pathlength 10, 20, 50 or 100 mm
Capacity	4 sample and 1 reference cell
Temperature	Ambient

SSE-704 - 6-position manual cell changer



Specifications

Sample Cell	Rectangular cell pathlength 10 mm
Reference Cell	Rectangular cell pathlength 10 mm
Capacity	6 sample and 1 reference cell
Temperature	Ambient

NCP-705 - 6-position automatic cell changer



Specifications

Sample Cell	Rectangular cell pathlength 10 mm
Reference Cell	Rectangular cell pathlength 10 mm
Capacity	6 sample and 1 reference cell
Temperature	Ambient
Cell Switching	Software Controlled
Suggested Software	<ul style="list-style-type: none"> VWIS-957 - Interval scan measurement program VWIS-958 - Temperature interval scan measurement program

CYH-708 - Cylindrical cell holder



Specifications

Sample Cell	Cylindrical cell pathlength 10, 20, 50 or 100 mm
Reference Cell	Cylindrical cell pathlength 10, 20, 50 or 100 mm
Capacity	1 sample and 1 reference cell
Temperature	Ambient

UCB-710 – Bio rectangular cell holder

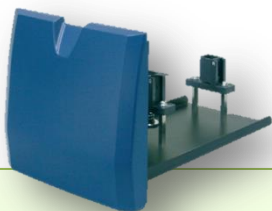

Specifications

A cell height adjustment function provides the ability to use a 100 μ L micro cell. A mask for a 100 μ L micro cell is standard, 50 μ L can be supplied as option.

Sample Cell	Rectangular cell pathlength 10 mm
Reference Cell	Rectangular cell pathlength 10 mm
Capacity	1 sample and 1 reference cell
Temperature	Ambient
Minimum Cell Volume	50 μ L

EMC-709 – Micro cell holder



Specifications

The EMC-709 is a cell holder for a 50 μ L micro cell. A 5 μ L micro cell can be used with an optional spacer.

Sample Cell	Rectangular cell pathlength 10 mm
Reference Cell	Rectangular cell pathlength 10 mm
Capacity	1 sample and 1 reference cell
Temperature	Ambient
Minimum Cell Volume	5 μ L

EMC-759 – Ultra-micro cell holder



Specifications

The EMC-759 is a cell holder for a 5 μ L micro cell

Sample Cell	Rectangular cell pathlength 10 mm
Reference Cell	Rectangular cell pathlength 10 mm
Capacity	1 sample and 1 reference cell
Temperature	Ambient
Minimum Cell Volume	5 μ L



50 μ L micro cell

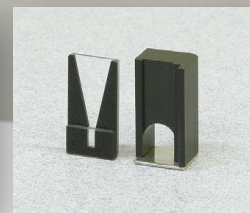

5 μ L micro cell and spacer

TCH-703 – 8-position Micro turret cell holder



Specifications

Cell holder for an optional 8-position turret micro cell, containing eight cells with a volume of approximately 4 μ L arranged in a circle.

Sample Cell	pathlength 1 mm
Capacity	8 sample cells
Temperature	Ambient
Cell Volume	4 μ L

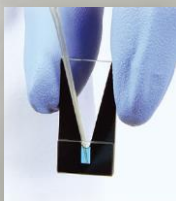

5 μ L micro cell

8-position micro turret cell
P/N: 6916-4822A

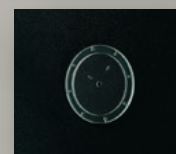

The following cell holder accessories can be used with water circulators for maintaining samples at a uniform temperature. The circulators available separately.

STR-773

Water thermostatted cell holder with stirrer



Specifications

Sample Cell	Rectangular cell 10 x 10, 4 x 10, 2 x 10 mm
Reference Cell	Rectangular cell 10 x 10, 4 x 10, 2 x 10 mm
Capacity	1 sample and 1 reference cell
Temperature Control	Thermostatted water circulation for sample and reference
Operating Temperature	10 to 90 degC
Stirrer	Integrated variable speed magnetic stirrer - 2 mm path width micro cell cannot be used with the stirrer

HMC-711

Water thermostatted micro cell holder



Specifications

Minimum sample volume is 50 µL by using a rectangular cell, 5 mm path length and 2 mm path width.

Sample Cell	Rectangular cell 10 x 10 or 5, 2 or 4 x 10, 2 x 5 mm
Reference Cell	Rectangular cell 10 x 10 or 5, 2 or 4 x 10, 2 x 5 mm
Capacity	1 sample and 1 reference cell
Temperature Control	Thermostatted water circulation for sample and reference
Operating Temperature	10 to 90 degC
Cell masks (standard)	<ul style="list-style-type: none"> Mask for 100 µL cell (2 pcs.) for micro cell, 2 x 10 mm Mask for 200 µL cell (2 pcs.) for micro cell, 4 x 10 mm

NCP-706

Water thermostatted 6-position automatic cell changer



Specifications

Sample Cell	Rectangular cell 10 x 10 or 5, 2 or 4 x 10, 2 x 5 mm
Reference Cell	Rectangular cell 10 x 10 or 5, 2 or 4 x 10, 2 x 5 mm
Capacity	6 sample and 1 reference cell
Temperature Control	Thermostatted water circulation for sample and reference
Operating Temperature	10 to 90 degC
Cell Switching	Software Controlled

MHT-745

Manual 4-position water thermostatted turret cell holder



Specifications

Sample Cell	Rectangular cell 10 x 10, 4 x 10 mm
Reference Cell	Rectangular cell 10 x 10, 4 x 10 mm
Capacity	4 sample and 1 reference cell
Temperature Control	Thermostatted water circulation for sample and reference
Operating Temperature	10 to 90 degC
Cell Switching	Manual

EHCS-760

**Peltier thermostatted single cell holder
(Air cooled)**



Specifications

Sample Cell	Rectangular cell 10 x 10, 4 x 10, 2 x 10 mm
Reference Cell	Rectangular cell 10 x 10, 4 x 10, 2 x 10 mm
Capacity	1 sample and 1 reference cell
Temperature Control	Sample only - Heating/cooling system using air cooled Peltier effect
Operating Temperature	10 to 60 degC (at 25 degC)
Temperature control accuracy	±0.1 degC (cell holder sensor)
Temperature Accuracy	With cell holder sensor ±0.5 degC (20 to 40 degC) ±1 degC (other temp. range) With optional temperature sensor ±0.2 degC
Stirrer	Integrated variable speed magnetic stirrer - 2 mm path width micro cell cannot be used with the stirrer
Suggested Software	<ul style="list-style-type: none"> VWIS-958 - Temperature interval scan measurement program VWTP-959 - Temperature Gradient measurement and DNA melting analysis program

CSP-909

Lid for sample compartment with syringe port

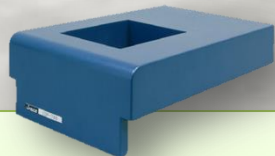

Specifications

When monitoring a substrate-enzyme reaction, this accessory allows addition of an enzyme solution without opening the sample chamber lid. Can only be used with a 10 x 10 mm rectangular cell. Required needle length for the syringe is 50 mm

Compatible Cell Holder	STR-733 EHCS-760 - ETCS-761 - ETCR-762
Syringe	P/N 0507-0220 – Micro syringe 10µL P/N 0507-0223 – Micro syringe 100µL

ETCS-761 & ETCR-762

**Peltier thermostatted single cell holder
(Water cooled)**



Sample Cell	Rectangular cell 10 x 10, 4 x 10, 2 x 10 mm
Reference Cell	Rectangular cell 10 x 10, 4 x 10, 2 x 10 mm
Capacity	1 sample and 1 reference cell
Temperature Control ETCS-761	Sample only Heating/cooling system using Water cooled Peltier effect
Temperature Control ETCR-762	Sample & Reference Heating/cooling system using Water cooled Peltier effect
Operating Temperature	0 to 100 degC for cooling water temperature at 25 degC
Temperature control accuracy	±0.1 degC (cell holder sensor)
Temperature Accuracy	With cell holder sensor ±0.5 degC (20 to 40 degC) ±1 degC (other temp. range) With optional temperature sensor ±0.2 degC
Stirrer	Integrated variable speed magnetic stirrer - 2 mm path width micro cell cannot be used with the stirrer
Suggested Software	<ul style="list-style-type: none"> VWIS-958 - Temperature interval scan measurement program VWTP-959 - Temperature Gradient measurement and DNA melting analysis program

Options

Cell Mask kit - includes sample masks and a cell-height adjustment stand to raise the cell height. Using the cell-height adjustment stand, a 2 mm path width micro cell can be used to measure sample with a minimum 100 µL volume.

OPS-515 - In-cell sensor with holder (factory option) - This is an optional sensor which can be used to monitor the temperature inside of the sample cell.

Cell Spacers - Spacers for cells with an optical path length of 1, 2 and 5 mm are available.

Capillary adapter - The capillary adapter is used for a capillary cell (minimum sample volume of 3 µL). The optional sensor (OPS-515) in the cell adapter is required for temperature monitoring.

PSC-763

**Automatic 6-position Peltier cell changer
(Air cooled)**



Specifications

Sample Cell	Rectangular cell 10 x 10, 4 x 10, 2 x 10 mm
Reference Cell	Rectangular cell 10 x 10, 4 x 10, 2 x 10 mm
Capacity	6 sample and 1 reference cell
Temperature Control	Sample only - Heating/cooling system utilizing air cooled Peltier effect
Operating Temperature	10 to 70 degC (at 20 degC)
Temperature control accuracy	±0.1 degC (cell holder sensor)
Temperature Accuracy	<i>With cell holder sensor</i> ±0.5 degC (20 to 40 degC) ±1 degC (other temp. range) <i>With optional temperature sensor</i> ±0.2 degC
Stirrer	Integrated variable speed magnetic stirrer - <i>2 mm path width micro cell cannot be used with the stirrer</i>
Suggested Software	<ul style="list-style-type: none"> VWIS-958 - Temperature interval scan measurement program VWTP-959 - Temperature Gradient measurement and DNA melting analysis program

Options

OPS-513 - In-cell sensor with holder (factory option) - This is an optional sensor which can be used to monitor the temperature inside of the sample cell.

PAC-743 & PAC-743R

**Automatic 6/8-position Peltier cell changer
(Water cooled)**



Specifications

Sample Cell	Rectangular cell 10 x 10, 4 x 10, 2 x 10 mm
Reference Cell	Rectangular cell 10 x 10, 4 x 10, 2 x 10 mm
Capacity	6/8 sample and 1 reference cell
Temperature Control PAC-743	Sample only Heating/cooling system utilizing Water cooled Peltier effect
Temperature Control PAC-743R	Sample & Reference Heating/cooling system utilizing Water cooled Peltier effect
Operating Temperature	0 to 100 degC (at 20 degC)
Temperature control accuracy	±0.1 degC (cell holder sensor)
Temperature Accuracy	<i>With cell holder sensor</i> ±0.5 degC (20 to 40 degC) ±1 degC (other temp. range)
Stirrer	Integrated variable speed magnetic stirrer - <i>2 mm path width micro cell cannot be used with the stirrer</i>
Suggested Software	<ul style="list-style-type: none"> VWIS-958 - Temperature interval scan measurement program VWTP-959 - Temperature Gradient measurement and DNA melting analysis program

MCB-100

Mini Water Circulation Bath



Specifications

Temperature control range	10 degC below ambient temperature to 40 degC (IN and OUT connected)
Bath capacity	Approx. 200 mL
Temperature sensor accuracy	±0.2 degC (at 20 degC)
Cooling/heating capacity	52W
Dimensions	160 (W) \x 278 (H) x 225 (D) mm
Suggested accessories	ETCS-761 – ETCR-762 – PAC-743

PAC-743 & PAC-743R

PAC-743 & PAC-743R allow measurements of the transmittance & absorbance of multiple samples by using dedicated cell blocks with temperature control.

The PAC-743R provides temperature control of the reference cell in addition to temperature control of the sample cells.

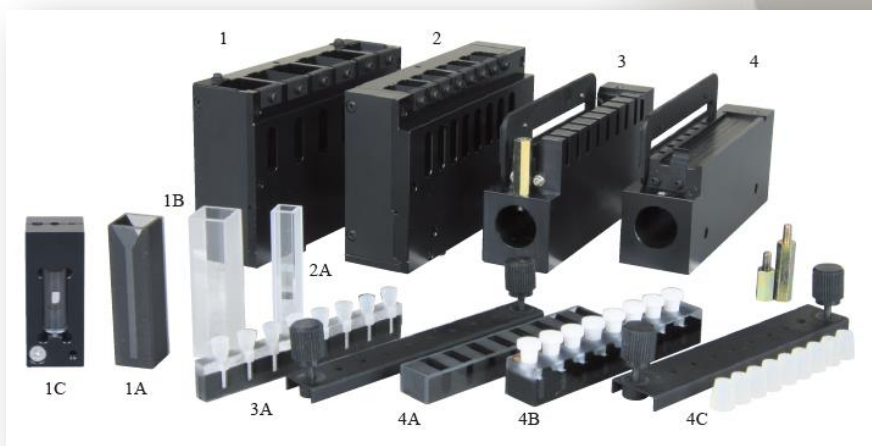

How to configure it

Cell block (Cell and temp. sensor are optional)	#	Compatible Cell	#	In-cell sensor (factory option)
6916-H243A - 6-position cell block (with variable speed magnetic stirrer) for rectangular cell, 10 x 10 mm	1	Rectangular quartz cell, 2 x 10 mm, max. 6pcs.	1A	6916-H516A Sensor in cell, 1 pc. 6916-H517A Sensor in cell, 6 pcs/set
		Rectangular quartz cell, 4 x 10 mm, max. 6pcs.		
		Rectangular quartz cell, 10 x 10 mm, max. 6pcs.	1B	
		6916-H360A - Capillary cell adaptor and Capillary cell, max. 6 pcs. (A sealing compound is required for using capillary cells.)	1C	
6916-H343A - 8-position cell block (with variable speed magnetic stirrer) for rectangular cell, 5 x 5 mm	2	Rectangular quartz cell, 5 x 5 mm, max 8 pcs.	2A	6916-H516A Sensor in cell, 1 pc. 6916-H518A Sensor in cell, 8 pcs/set
6916-H643A - 1 mm 8-position micro cell block (Including Silicon cap x 8, Silicon cap with sensor hole x1, and cap fixture) *Stirrer function is not available	3	1103-1171A - 8-position 1 mm micro cell 1 mm path length, 10 µL for each position	3A	6916-H516A Sensor in cell, 1 pc. *The 8th cell position is used only to monitor cell block temperature.
6916-H743A - 10 mm 8-position micro cell block *Stirrer function is not available	4	1103-0202A - 8-position 10 mm micro cell 10 mm path length, 100 µL for each position without capability for well caps	4A	N/A
		1103-1168 - 8-position 10 mm micro cell with Teflon caps 10 mm path length, 100 µL for each position	4B	6916-H516A Sensor in cell, 1 pc. *The 8th cell position is used only to monitor cell block temperature.
		6916-H543A - Silicon cap kit for 1103-1168, to prevent volatilization of samples at high temperatures consisting of silicon cap x8 , Silicon cap with sensor hole x1, and cap fixture	4C	

SAH-769 One drop accessory

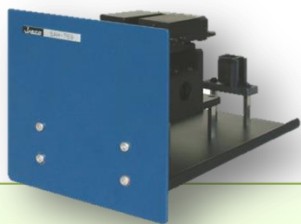

Specifications

The SAH-769 One Drop accessory is a dedicated accessory for the V-700 Series to measure micro volume samples of protein and nucleic acid. The 1mm and 0.2 mm cells are included as standard with accessory.

Minimum Sample Volume

1mm pathlength	5 μ L
0.2mm pathlength	0.6 μ L

Precision of Quantitative Analysis

Solutions of Calf Thymus DNA (KH₂PO₄ / NaOH buffer at pH7) at several concentrations were measured by using cells with 1-mm. The spectrum has shown at Figure 1 and LDL has shown at Table 1.

Table 1 Sample Conc. and Abs [OP: 1mm]

Legend	Conc. [ng/ μ L]	Abs
—	0	0.0005
—	13	0.0228
—	26	0.0417
—	52	0.0838
—	260	0.4500
—	520	0.8970
—	780	1.3443
—	1040	1.8137

Table 1

Sample Concentration and Abs
[optical path: 1 mm]

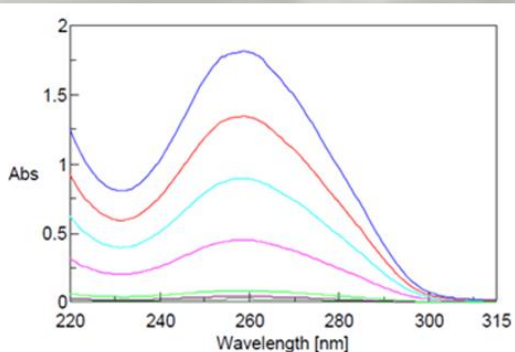

Figure 1

Absorbance spectra of DNA solution
[optical path: 1 mm]

Measurement Procedure



1) Drop sample on the cell

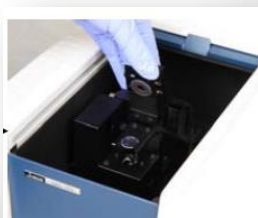

2) Close the cover glass and the lid of sample compartment



3) Start sample measurement

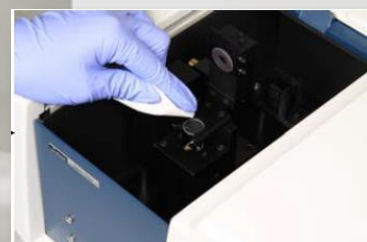

4) Cleaning the cell

less than
20 seconds

Measurement Parameters

Data interval: 0.5 nm
Measurement range: 220 to 315 nm
Band width: 1.5 nm
Response: Medium
Scan Speed: 200 nm/min

ASU-800 autosampler, combined with a syringe pump and a flow cell or a variety of sippers, automatically measures multiple liquid samples using spectrophotometer V-700 series. Tubes or tube racks according to the sample volume and the amount of samples, or dedicated racks for microplates can be purchased separately. PC control software is included as standard.

ASU-800 can be coupled with the following accessories:

- **NQF-781** - Vacuum sipper
- **NQF-783** - Vacuum sipper with long-path flow cell
- **NPF-721** - Peristaltic sipper
- **ASP-849** - Syringe pump

- **SFC-712** - Flow cell holder
- **MFC-714** - Micro flow cell holder
- **FIC-715** - Micro flow cell holder

- **AWU-828** Washing unit
- **Dust Cover**

ASU-800 - Autosampler unit



Rack	Tube/Microplate/Vials
6989-J111A – SRA-811 15 mm O.D. test tube rack - 100 samples	6774-H110A 15 mm O.D. test tube, 15 mm (O.D.) x 105 mm (H) - 10 mL - 100 pcs/set
6989-J112A – SRA-812 13 mm O.D. test tube rack – 100 samples	6774-H109A 13 mm O.D. test tube, 13 mm (O.D.) x 100 mm (H) - 7 mL - 100 pcs/set
6989-J113A – SRA-813 12 mm O.D. test tube rack – 150 samples	6905-H146A 12 mm O.D. test tube, 12 mm (O.D.) x 105 mm (H) - 5 mL - 100 pcs/set
6989-J114A – SRA-814 10 mm O.D. test tube rack – 150 samples	6774-H111A 10 mm O.D. test tube, 10 mm (O.D.) x 90 mm (H) - 3 mL - 100 pcs/set
6989-J116A - SRA-816 Microplate Rack – 192 samples	Commercially available 1ml 96-well microplates
6989-J117A - SRA-817 Thermostatted Microplate Rack – 192 samples	Commercially available 1ml 96-well microplates
6989-J118A – SRA-818 Vial Rack	0410-0102 Screw top vial – 1.5 mL - 500 pcs./set

Specifications

Nozzle	SUS-316 - 1.5 mm (O.D.) x 1.1 mm (I.D.)
Tubing	Teflon – 2.0 mm (O.D.) x 1.0 mm (I.D.)
Software	Fully controlled by Personal Computer - Included as standard: Spectra Measurement, Quantitative Calibration, Quantitative Analysis and Fixed Wavelength Measurement
Communication	USB



AWU-828 Washing Unit

Washing unit specifically design for the sippers NQF-781, NQF-783 and NPF-782.

The AWU-828 can automatically wash the ASU-800 autosampler system.



Dust cover

This is a dust case that covers the rack part of ASU-800

NQF-781 – Vacuum sipper



Specifications

NQF-781 can be used in conjunction with the autosampler ASU-800. A 10 mm rectangular cell holder is integrated in addition to the 10 mm flow cell, and can be easily switched.

Optical Pathlength	10 mm
Cell Capacity	about 50 μ L
Cell Material	Quartz
Carryover	Less than 1%
Minimum sample requirement	0.7 mL for low-viscosity samples
Material in contact with sample/solvent	Teflon, Fluoroelastomer, Aflon
Maximum Processing Capacity	450 samples/hour
Wavelength Range	220 - 900 nm (V-750/760) 220 - 2200 nm (V-770) 220 - 1600 nm (V-780)

NQF-783

Vacuum sipper with long-path flow cell



Specifications

NQF-783 can be used in conjunction with the autosampler ASU-800. A 50 mm rectangular cell holder is integrated in addition to the 50 mm flow cell, and can be easily switched.

Optical Pathlength	50 mm
Cell Capacity	about 1400 μ L
Cell Material	Quartz
Carryover	Less than 1%
Minimum sample requirement	2.4 mL for low-viscosity samples
Material in contact with sample/solvent	Teflon, Fluoroelastomer, Aflon
Maximum Processing Capacity	450 samples/hour
Wavelength Range	220 - 900 nm (V-750/760) 220 - 2200 nm (V-770) 220 - 1600 nm (V-780)

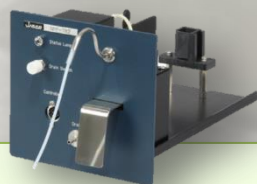

NPF-782 – Peristaltic sipper

Specifications

NPF-782 can be used in conjunction with the autosampler ASU-800. A 10 mm rectangular cell holder is integrated in addition to the 10 mm flow cell, and can be easily switched. The sample can be recovered by reversing the 'drain' direction.

Optical Pathlength	10 mm
Cell Capacity	about 50 μ L
Cell Material	Quartz
Carryover	Less than 1%
Minimum sample requirement	0.7 mL for low-viscosity samples
Material in contact with sample/solvent	Teflon, Fluoroelastomer, Aflon
Maximum Processing Capacity	360 samples/hour
Wavelength Range	220 - 900 nm (V-750/760) 220 - 2200 nm (V-770) 220 - 1600 nm (V-780)

ASP-849 – Syringe Pump



Specifications

The ASP-849 can be used in conjunction with the ASU-800 and SFC-712/MFC-714/FIC-715 flow cell holders. The syringe pump is suitable for drawing small quantities of sample.

Reproducibility of volume delivery	Within $\pm 1\%$
Syringe volume	2.5 mL (included as standard)
Optional syringes	1 mL – 5 mL – 10 mL
Material in contact with sample/solvent	Teflon, Fluoroelastomer, Quartz
Compatible Flow Cell Holders	SFC-712 MFC-714 FIC-715

SFC-712 – Flow cell holder



Specifications

Flow Cell compatibility	6156-H607A 5 mm path length flow cell (50 μL cell capacity)
	6156-H608A 10 mm path length flow cell (100 μL cell capacity)
Flow Cell	Rectangular Quartz
Material in contact with sample/solvent	Teflon, Fluoroelastomer, Quartz
Wavelength Range	220 - 900 nm (V-750/760)
	220 - 2200 nm (V-770)
	220 - 1600 nm (V-780)

MFC-714 – Micro Flow cell holder FIC-715 – Micro Flow cell holder



Specifications

Cell Material	MFC-714: SUS FIC-715: Teflon
Optical Pathlength	10 mm
Cell Capacity	20 μL

LFC-713 – Long path flow cell holder



Specifications

Flow Cell compatibility	6522-J343A 30 mm path length flow cell (approx. 0.6 mL cell capacity)
	6522-J333A 50 mm path length flow cell (approx. 1 mL cell capacity)
	6522-J243A 100 mm path length flow cell (approx. 2 mL cell capacity)
Flow Cell	Synthetic Fused Silica
Wavelength Range	220 - 900 nm (V-750/760)
	220 - 2200 nm (V-770)
	220 - 1600 nm (V-780)

FLH-740 – Film holder



Specifications

FLH-740 accessory are used to measure the transmittance of solid, transparent samples such as films, plate glass, and filters.

Minimum Sample size 15 mm (H) x 15 mm (W)

Maximum Sample size 80 mm (H) x 100 mm (W)

Sample Thickness 0.5 to 10 mm

Insert Mode Leaf Spring type

FLH-741 – Film holder



Specifications

FLH-741 accessory are used to measure the transmittance of solid, transparent samples such as films, plate glass, and filters.

Minimum Sample size 5 mm (H) x 5 mm (W)

Maximum Sample size 80 mm (H) x 100 mm (W)

Sample Thickness 0.5 to 25 mm

Insert Mode Holding Plate type

RSH-744 – Rotary sample holder



Specifications

RSH-744 accessory can be used to measure a film type sample and rotating the sample manually. The sample can be rotated 360° around the optical axis and the inclination (tilt) of the sample versus the source beam can be varied within a range of $\pm 50^\circ$.

Minimum Sample size 10 mm (H) x 30 mm (W)

Maximum Sample size 18 mm (H) x 38 mm (W)

Sample Thickness 1 to 2 mm

Rotation Angle Optical axis: 360°
Perpendicular to the optical axis: $\pm 50^\circ$

VTA-752 – Film holder (variable incident angle)



Specifications

VTA-752 is a film holder to measure transmittance of a film type sample, changing the incident angle of the light beam. The incident angle of the source light beam can be set in 1° increments.

Minimum Sample size 15 mm (H) x 35 mm (W)

Maximum Sample size 80 mm (H) x 70 mm (W)

Sample Thickness 1 to 2 mm

Rotation Angle $\pm 90^\circ$

SLM-907 – Specular Reflectance accessory

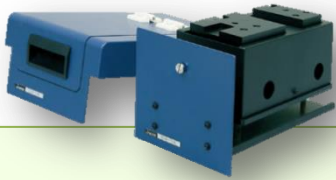

Specifications

SLM-907 accessory is designed to measure the relative reflectance of a sample using the reflected light from an aluminum-deposited plane mirror as a reference. This accessory allows measurement of the reflectance of metal-deposited films and/or metal Plating, as well as measurement of film thickness using a film thickness analysis program.

Incident angle	Approx. 5°
Minimum Sample size	10 x 10 mm
Maximum Sample size	100 x 120 mm
Beam Port	7 mm diam. (1 mm, 2 mm diam. Options)
Reflection Reference	Aluminum-deposited plane mirror (Standard)
Wavelength range	200 - 870 nm (V-750/760) 200 - 2500 nm (V-770) 200 - 1600 nm (V-780)
Sample chamber lid	Included as standard

Options

	MSK-001	MSK-002
Sample stage with mask	2 mm diam.	4 mm diam.
Minimum Sample Size	3 x 3 mm	5 x 5 mm
Maximum Sample Size	50 x 50 mm	50 x 50 mm
Suggested Software	VWRR-769 - Reflectance correction program	

VWRR-769

Reflectance correction program

VWRR-769 program can convert a relative reflectance spectrum, obtained by using a specular reflectance accessory, to an absolute reflectance spectrum by multiplying the absolute reflectance spectrum of the reflectance standard with a relative reflectance spectrum of the sample.

VWRR-769 software includes typical absolute reflectance data of an evaporated aluminum mirror for conversion.

Required Accessories	SLM-907-SLM-908
-----------------------------	-----------------



SLM-908

Specular Reflectance accessory

Specifications

SLM-908 accessory is designed to measure the relative reflectance of a sample using the reflected light from an aluminum-deposited plane mirror as a reference. This accessory allows measurement of the reflectance of metal-deposited films and/or metal Plating, as well as measurement of film thickness using a film thickness analysis program. SLM-908 accessory can measure larger samples such as 6 inch silicon wafers.

Incident angle	Approx. 5°
Sample size	150 mm diam.
Beam Port	7 x 7 mm
Reflection Reference	Aluminum-deposited plane mirror (Standard)
Wavelength range	200 - 870 nm (V-750/760) 200 - 2500 nm (V-770) 200 - 1600 nm (V-780)
Sample chamber lid	Included as standard

Options

	MSK-001	MSK-002
Sample stage with mask	2 mm diam.	4 mm diam.
Minimum Sample Size	3 x 3 mm	5 x 5 mm
Maximum Sample Size	50 x 50 mm	50 x 50 mm
Suggested Software	VWRR-769 - Reflectance correction program	



DPL-515 – Depolarization Plate

Specifications

DPL-515 depolarizer converts incident light to non-polarized light. Non-polarized light is obtained when the rotation angle is set to 45°. The applicable spectral range is from 350 to 2,500 nm.



GPH-506 – Polarizer

Specifications

GPH-506 polarizer converts the source light from the instrument monochromator into linearly polarized light. The plane of polarization can be set at 0° (vertical linearly polarized light) and 90° (horizontal linearly polarized light). The applicable spectral range is from 215 to 2,300 nm.

ISV-922 - Integrating Sphere, 60 mm



Specifications

The ISV-922 integrating sphere are provided with a light trap so that the reflectance of samples can be measured with or without the specular reflectance component. The rectangular cell holder for diffuse transmittance of a turbid liquid sample and holders for diffuse reflectance of solid samples are standard. A range of sample holders, a fluorescence cut filter and polarizer are available as options.

Inside diameter of integrating sphere	60 mm
Minimum sample size (Reflectance)	20 (H) x 20 (W) x 0.5 (t) mm
Maximum sample size (Reflectance)	65 (H) x 50 (W) x 25 (t) mm
Sample cell (Transmittance)	Rectangular cell 5, 10, 20, 30, 50 mm path length
Reference cell (Transmittance)	Rectangular cell 5, 10, 20 mm path length (Reference cell block is optional)
Wavelength range	200 - 870 nm
On-board Detector	PMT
Incident angle to reflection surface	0°, approx. 5°

Options

PSH-002 Powder sample holder - For diffuse reflectance measurements of powder samples - Size of sample area: 16 mm diameter - Thickness: 0.5 - 6 mm

PSH-003 Powder sample holder - For diffuse reflectance measurements of small amount of powder samples - Size of sample area: 5 mm diameter - Thickness: 0.5 - 4 mm - (*) The lens and mask kit is required

SSH-506 Solid Sample Holder
For diffuse transmittance measurements of a solid sample
Min. sample size: 20 (H) x 20 (W) x 0.5 (t) mm
Max. sample size: 70 (H) x 40 (W) x 35 (t) mm

RLH-603 Reference Side rectangular cell holder
This cell holder is used for the reference side when performing diffuse transmittance measurements of turbid liquid samples. Cell to be used: 5, 10 or 20 mm optical pathlength rectangular cell

(*) 6916-H123A Lens and mask kit
This accessory kit consists of a lens to focus the light beam onto a small amount of a powder sample and three types of masks (1, 2, 3 mm diam.). The lens focuses the beam down to a 1 mm diameter by using the 1 mm diam. mask for diffuse reflectance measurements of a very small area of the sample.

ILV-924 - Integrating Sphere, 150 mm



Specifications

ILV-924 integrating sphere are provided with a light trap so that the reflectance of samples can be measured with or without the specular reflectance component. The rectangular cell holder for diffuse transmittance of a turbid liquid sample and holders for diffuse reflectance of solid samples are standard. A range of sample holders, a fluorescence cut filter and polarizer are available as options.

Inside diameter of integrating sphere	150 mm
Minimum sample size (Reflectance)	20 (H) x 20 (W) x 0.5 (t) mm
Maximum sample size (Reflectance)	100 (H) x 50 (W) x 30 (t) mm
Sample cell (Transmittance)	Rectangular cell 5, 10, 20 30, 50 mm path length
Reference cell (Transmittance)	Rectangular cell 5, 10, 20 30, 50 mm path length
Wavelength range	200 - 850 nm
On-board Detector	PMT
Incident angle to reflection surface	approx. 5°

Options

PSH-002 Powder sample holder
For diffuse reflectance measurements of powder samples
Size of sample area: 16 mm diameter
Thickness: 0.5 - 6 mm

SSH-507 Solid sample holder
For diffuse transmittance measurements of a solid sample
Min. sample size: 20 (H) x 20 (W) x 0.5 (t) mm
Max. sample size: 70 (H) x 30 (W) x 40 (t) mm

Integrating spheres are designed to measure either the diffuse transmittance or diffuse reflectance of a sample. Usually, the UV-Vis/NIR spectrophotometers measure the transmittance of a homogeneous, transparent liquid or solid sample. However, when a turbid liquid sample or opaque solid sample is measured, the light incident upon the sample is diffusely transmitted or reflected and only a small portion of the light reaches the detector. The integrating sphere accessory acquires the light diffuse-transmitted or diffuse-reflected from the sample into the integrating sphere and introduces it to the detector.

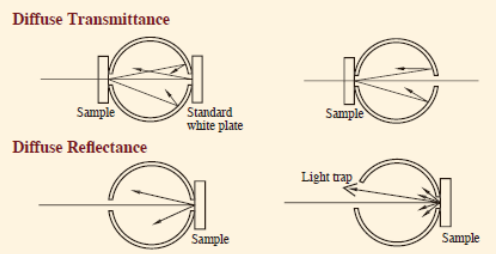

SIV-767 - Integrating sphere with stirrer

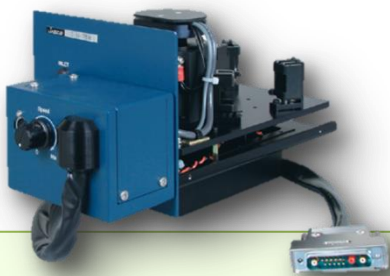

Specifications

SIV-767 includes a rectangular cell holder for diffuse transmittance of a turbid liquid sample and holders for diffuse reflectance of solid samples as standard. The standard magnetic stirrer for a 10 mm path length rectangular cell enables diffuse transmittance measurements of turbid liquid samples, using the stirrer to maintain sample homogeneity. A thermostatted cell holder for the 10 mm rectangular cell is also available as an option.

Inside diameter of integrating sphere	60 mm
Cell (Sample side)	Rectangular cell 5, 10, 20, 30, 50 mm path length
Cell (Reference side)	Rectangular cell 5, 10, 20 mm path length * Reference cell block is optional
Minimum Sample size Reflectance measurement	20 (H) x 20 (W) x 0.5 (T) mm
Maximum Sample size Reflectance measurement	65 (H) x 50 (W) x 25 (T) mm
Wavelength range	250 - 800 nm
Stirring system	Integrated variable speed magnetic stirrer
On-board Detector	PMT

Options

RLH-603 Reference-side rectangular cell holder

This cell holder is required for the reference side when performing diffuse transmittance measurements of turbid liquid samples. The 5, 10 and 20 mm pathlength rectangular cells can be used with this cell holder.

6916-J367A - Thermostatted Cell Holder

This cell holder allows measurements under temperature control by using a 10 x 10 mm rectangular cell with a temperature range of 10 to 90°C. A thermostatted water circulator is required.

* This cell holder cannot be used with the RLH-603.

PIV-756 - Horizontal integrating sphere



Specifications

PIV-756 can mount samples horizontally and allows the simple measurement of small and powder samples with little to no sample preparation.

Inside diameter of integrating sphere	60 mm
Minimum sample size (Transmittance)	3 mm diam.x 0.5 (T) mm
Maximum sample size (Transmittance)	50 (H) x 50 (W) x 2 (T) mm
Maximum sample size (Reflectance)	30 x 30 x 10 (T) mm
Reflectance measurement adaptor	20 mm diam. x 2 mm (no window required)
Wavelength range	250 - 850 nm
On-board Detector	PMT

Options

6916-J156A - Lens and mask for reflectance measurement - (mask size: 1, 2 and 3 mm diam.)

6916-J256A - Lens and mask for transmittance measurement - (mask size: 1, 2 and 3 mm diam.)

These lens and mask kits are used to focus the light beam for measurement of a small area. When the 1 mm diameter mask is used, the beam diameter of the incident light upon the sample is decreased to a minimum of 2 mm in diameter.

IJV-726

Dedicated Gemstone integrating sphere

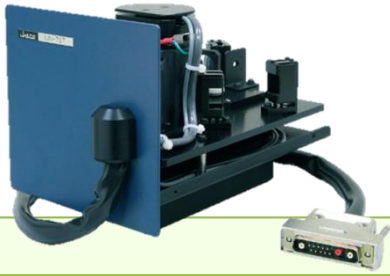

Specifications

IJV-726 is specially designed to measure the diffuse transmittance and diffuse reflectance of small and irregularly shaped samples such as gemstones. Various sample holders are included as standard for measurements of precious stones mounted on rings and necklaces. Use with the GHP-506 polarizer (option) is recommended.

Inside diameter of integrating sphere	60 mm
Minimum sample size (Transmittance/Reflectance)	2 mm diameter
Maximum sample size (Transmittance)	10 mm diameter
Maximum sample size (Reflectance)	30 mm diameter
Wavelength range	220 - 850 nm
On-board Detector	PMT

Options

Sample holders for rings, pearls, gemstones (included as standard)

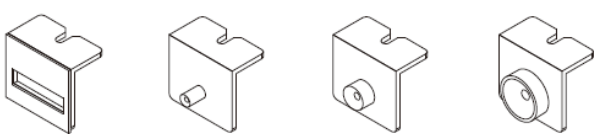

HISV-728 - Portable integrating sphere



Specifications

HISV-728 accessory is suitable for the diffuse reflectance measurement of a sample which cannot be accommodated in the standard sample chamber. Select from the optional, dedicated optical fibers of 1 or 2 meter length, as required.

Inside diameter of integrating sphere	60 mm
Windows Size	25 mm diameter
Wavelength range	250 - 800 nm
On-board Detector	PMT

Options

OFV-624/625 Optical fiber for HISV-728
 Length: 1 m (OFV-624), 2 m (OFV-625)
 Wavelength range: 250 - 800 nm



ARMV-919 Automated Absolute Reflectance measurement accessory



Specifications

Wavelength range	250 - 850 nm
Movement of sample stage and detector	Asynchronous
Control of sample stage and detector	Automated
Measurement mode	Absolute reflectance Relative reflectance
Integrating sphere	60 mm
Incidence angle	<i>Absolute reflectance mode</i> 5° to 60°
	<i>Relative reflectance mode</i> Vertical incidence
	<i>Transmittance mode</i> 5° to 60°
Angle setting	Sample stage: 0.1° step (manual) Detector stage: 1° step (manual)
Minimum sample size (Absolute Reflectance)	20 (H) x 20 (W) x 1 (t) mm
Maximum sample size (Absolute Reflectance)	70 (H) x 100 (W) x 10 (t) mm
Minimum sample size (Relative Reflectance)	20(H) x 20(W) x 0.5(T) mm
Maximum sample size (Relative Reflectance)	70(H) x 100(W) x 10(T) mm
Accuracy	±1.5% at incidence angle of 6°
100% line flatness	Within ±1%
Polarizer	Included as standard
Software included	<ul style="list-style-type: none"> Absolute reflectance spectral measurement Interval analysis

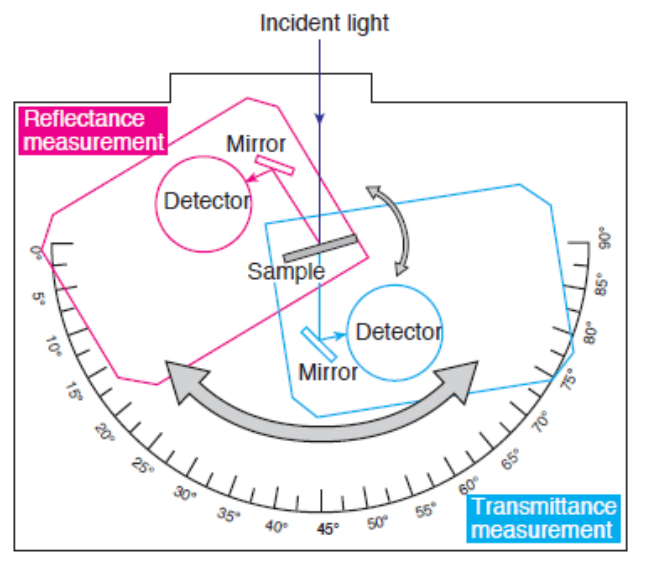

The ARMV-919 automates the absolute reflectance measurements of specularly reflecting samples such as metal or glass samples. The detector is equipped with an integrating sphere and thus it also permits measurement of the relative reflectance of a diffusely reflecting sample. Since the angles of the sample stage and the detector can be changed independently, the absolute reflectance and transmittance of a sample can be measured with varied angles of incidence. A software controlled polarizer is provided as standard for the examination of the polarization properties of a sample. In addition to S and P polarized lights, N polarized light that obtains the same measurement results as non-polarized light is available.

The interval data analysis program which is standard for the ARMV-919 can display the measurement results in three dimensions of the wavelength, photometric value and angle.

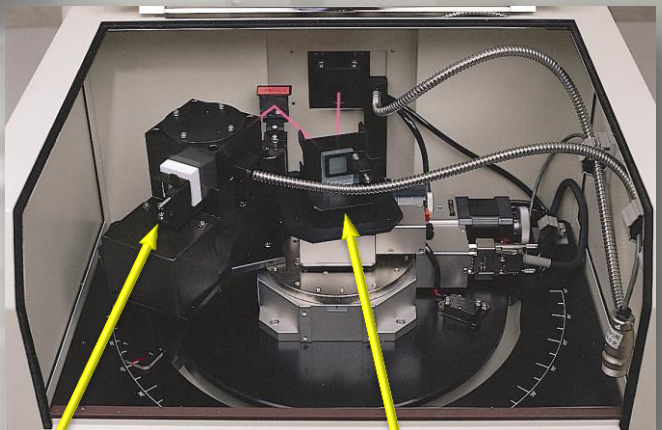

Integrating sphere

Sample Stage

ARV-913

Absolute Reflectance measurement accessory (Synchronous type)



Specifications

The ARV-913 accessory provides absolute reflectance measurements of samples by the manual, synchronous movement of the sample stage and detector.

Changing the incident angle of the sample by manually moving the detector position, the absolute reflectance of the sample can be measured at varied incident angles.

Using the optional ARG-476 or GPH-506 polarizers, the polarization properties of the sample can also be examined.

Wavelength range	250 - 850 nm
Movement of sample stage and detector	Synchronous
Control of sample stage and detector	Manual
Measurement mode	Absolute reflectance Relative reflectance
Integrating sphere	60 mm
Incidence angle	<i>Absolute reflectance mode</i> 5° to 60° <i>Relative reflectance mode</i> Vertical incidence
Angle setting	2.5° step (manual)
Minimum sample size (Absolute Reflectance)	20 (H) x 20 (W) x 1 (t) mm
Maximum sample size (Absolute Reflectance)	70 (H) x 100 (W) x 10 (t) mm
Minimum sample size (Relative Reflectance)	20(H) x 20(W) x 0.5(T) mm
Maximum sample size (Relative Reflectance)	70(H) x 100(W) x 10(T) mm
Accuracy	±1.5% at incidence angle of 6°
100% line flatness	Within ±1%
Polarizer	Optional (ARG-476 or GPH-506)

ARSV-916

Absolute Reflectance measurement accessory (Asynchronous type)



Specifications

The ARSV-916 accessory provides absolute reflectance measurements of samples by the manual, asynchronous movement of the sample stage and detector, thus, the positions of the sample stage and detector can be independently varied to obtain the absolute reflectance and transmittance spectra of the sample at varied incident and detection angles.

Using the optional ARG-476 or GPH-506 polarizers, the polarization properties of the sample can also be examined.

Wavelength range	250 - 850 nm
Movement of sample stage and detector	Asynchronous
Control of sample stage and detector	Manual
Measurement mode	Absolute reflectance Relative reflectance
Integrating sphere	60 mm
Incidence angle	<i>Absolute reflectance mode</i> 5° to 60° <i>Relative reflectance mode</i> Vertical incidence <i>Transmittance mode</i> 5° to 60°
Angle setting	Sample stage: 0.1° step (manual) Detector stage: 1° step (manual)
Minimum sample size (Absolute Reflectance)	20 (H) x 20 (W) x 1 (t) mm
Maximum sample size (Absolute Reflectance)	70 (H) x 100 (W) x 10 (t) mm
Minimum sample size (Relative Reflectance)	20(H) x 20(W) x 0.5(T) mm
Maximum sample size (Relative Reflectance)	70(H) x 100(W) x 10(T) mm
Accuracy	±1.5% at incidence angle of 6°
100% line flatness	Within ±1%
Polarizer	Optional (ARG-476 or GPH-506)

Absolute Reflectance accessories

Options

SSH-508 Solid sample holder

The SSH-508 is set on the entrance to the detector for diffuse transmittance measurements of scattering samples at a vertical (0°) incidence.

Minimum sample size 30(H) x 30(W) x 0.5(T) mm

Maximum sample size 70(H) x 80(W) x 10(T) mm

Wide incident angle sample holder

This sample holder is attached to the sample stage to allow an angle of incidence up to a maximum of 85°.

- 6708-H163A for ARV and ARSV
- 6708-H460A for ARMV

ARV
Minimum sample size 30(H) x 60(W) x 1(T) mm

ARSV - ARMV
Minimum sample size 30(H) x 30(W) x 1(T) mm

Maximum sample size 70(H) x 100(W) x 10(T) mm

Incidence angle 0° - 85°

PDU-755 Phase difference measurement unit

PDU-755 option provides the measurement of the reflectance phase difference and the transmittance phase difference. It consists of an angle selective analyzer and the VWAP-794 phase difference measurement program (included)

Wavelength range 250 - 850 nm

Polarization rotation angle 0° - 90°

ARG-476 Polarizer

The ARG-476 is a Glan-Taylor polarizer and is recommended for absolute reflectance measurements using incident angles of 30° or greater. By setting the polarizer at 45°, the same result can be obtained as for measurements with non-polarized light.

Wavelength range 250 - 850 nm

Polarization rotation angle 0° - 90°

Absolute Reflectance accessories

Softwares

VWAP-794

Phase difference measurement program

VWAP-794 software is included in the PDU-755 phase difference measurement accessory as standard.

VWAP-794 program measures transmittance and reflectance phase difference spectra with multiple incident angles by using a polarizer and analyzer.

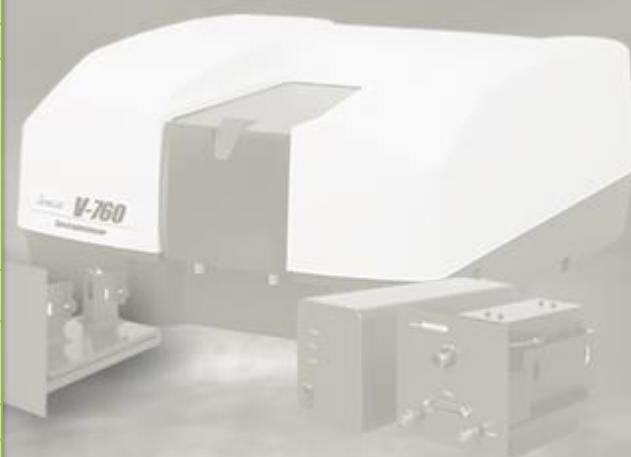

FAV-750 - Optical fiber unit



Specifications

FAV-750 accessory consisting of an optical fiber unit and external detector, enables the measurement of bulky samples that cannot be set in the sample compartment and/or samples that are in special environments. The light from the main instrument is introduced to the optical fiber. The light from a sample is introduced to the external detector via the optical fiber.

External detector Photomultiplier tube

Wavelength range 250 - 800 nm

Options

6916-J254A
Fiber connection port, Bundle type for FAV-750

6916-J250A
Fiber connection port, FC connector type for FAV-750

6916-J251A
Fiber connection port, SMA connector type for FAV-750

FAP-754 - Optical fiber unit



Specifications

FAP-754 accessory can be used for sample measurement using the internal detector of the spectrophotometer. The light from the main instrument is introduced to an optical fiber. The light from a sample is introduced to the detector of the spectrophotometer via a return optical fiber.

Options

6916-J154A
Fiber connection port, Bundle type for FAP-754

6916-J150A
Fiber connection port, FC connector type for FAP-754

6916-J151A
Fiber connection port, SMA connector type for FAP-754

ELM-912 - External light source interface



Specifications

This interface is for introducing light from an external light source into the spectrophotometer, and measuring the spectrum of the external source. It can be used for the spectral/intensity evaluation of external light sources.

* For correction of the measured spectrum, a secondary reference source is also required.

Options

1120-0109 - Optical fiber (bundle type), 1m

1120-0110 - Optical fiber (bundle type), 1.5m



Biochemical Softwares

VWKN-772

Kinetics analysis program

VWKN-772 Kinetics Analysis program performs time course measurements of multiple samples, plots the graphs and calculates the maximum reaction velocity (Vmax), Michaelis Menten constant (Km) and the Hill constant (n).

The program also supports calculation of inhibitor constant and determination of inhibitor type by comparing data obtained with and without an inhibitor. An automated cell changer can be utilized, enabling batch analysis of multiple data.

Five types of plots

- Michaelis-Menten
- Lineweaver-Burk
- Hofstee
- Eadie
- Hill

Calculation items

- Maximum reaction velocity (Vmax)
- Michaelis-Menten constant (Km)
- Hill constant (n)
- determination of inhibitor type
- inhibitor constant

CFR compliant YES

VWPN-952

Protein nucleic acid quantitation program

VWPN-952 program measures the absorbance of protein and nucleic acid solutions at specified wavelengths and calculates the concentration of the protein and nucleic acids based on a calculation method selected from five different types listed below. It is possible to select the wavelength for baseline correction and to choose whether baseline correction is to be performed. Generally, correction is performed for turbid solutions at a wavelength of 320 nm. Dilution rate correction is also possible for the user-defined concentration calculation method.

Available calculation methods

- Absorbance ratio of 280/260 nm
- Absorbance ratio of 230/260 nm
- Warburg-Christian method
- User-defined absorbance ratio
- User-defined concentration calculation

CFR compliant YES

VWTP-959

Temperature Gradient measurement and DNA melting analysis program

VWTP-959 temperature programming software offers DNA or protein melting analysis.

Controlling the temperature of a Peltier accessory (single or multi-cell), the VWTP-959 provides measurement of the absorbance at a specific wavelength during temperature changes, then calculates the melting temperature (Tm) from the results of the measurement.

Suggested Accessories EHCS -760 - ETCS-761 – ETCR-762
PSC-763 - PAC-743

CFR compliant YES

VWIS-957

Interval scan measurement program

VWIS-957 program measures spectra of samples automatically with a user-defined time interval between scans. The final data array can be displayed as a 2-D spectral display; a 3-D spectral display; contour, color-image or cross-section images; or 2-D displays of the peak height/ratio, peak area/ratio, FWHM or peak shift calculations. Data plots similar to the VWIS-957 software can be obtained using the VWTS-958 data array.

VWIS-957 can be used with an automated cell changer accessory for spectral data collection of multiple samples.

Suggested Accessories NCP-705

CFR compliant YES

VWIS-958

Temperature interval scan measurement program

VWTS-958 program measures spectra of samples automatically with a user-defined temperature interval between scans, providing a data array similar to the VWIS-957 program, but related to sample temperature. VWTS-958 can be used with an automated cell changer and/or with Thermostatted Single or Multiple holders for spectral data collection of multiple samples.

Suggested Accessories NCP-705
EHCS -760 - ETCS-761 – ETCR-762
PSC-763 - PAC-743

CFR compliant YES

Biochemical Package

VWKN-772

Kinetics analysis program

VWKN-772 Kinetics Analysis program performs time course measurements of multiple samples, plots the graphs and calculates the maximum reaction velocity (Vmax), Michaelis Menten constant (Km) and the Hill constant (n).

The program also supports calculation of inhibitor constant and determination of inhibitor type by comparing data obtained with and without an inhibitor. An automated cell changer can be utilized, enabling batch analysis of multiple data.

Five types of plots

- Michaelis-Menten
- Lineweaver-Burk
- Hofstee
- Eadie
- Hill

Calculation items

- Maximum reaction velocity (Vmax)
- Michaelis-Menten constant (Km)
- Hill constant (n)
- determination of inhibitor type
- inhibitor constant

CFR compliant	YES
----------------------	-----

VWTP-959

Temperature Gradient measurement and DNA melting analysis program

VWTP-959 temperature programming software offers DNA or protein melting analysis.

Controlling the temperature of a Peltier accessory (single or multi-cell), the VWTP-959 provides measurement of the absorbance at a specific wavelength during temperature changes, then calculates the melting temperature (Tm) from the results of the measurement.

Suggested Accessories	EHCS -760 - ETCS-761 – ETCR-762 PSC-763 - PAC-743
------------------------------	--

CFR compliant	YES
----------------------	-----

VWPN-952

Protein nucleic acid quantitation program

VWPN-952 program measures the absorbance of protein and nucleic acid solutions at specified wavelengths and calculates the concentration of the protein and nucleic acids based on a calculation method selected from five different types listed below. It is possible to select the wavelength for baseline correction and to choose whether baseline correction is to be performed. Generally, correction is performed for turbid solutions at a wavelength of 320 nm. Dilution rate correction is also possible for the user-defined concentration calculation method.

Available calculation methods

- Absorbance ratio of 280/260 nm
- Absorbance ratio of 230/260 nm
- Warburg-Christian method
- User-defined absorbance ratio
- User-defined concentration calculation

CFR compliant	YES
----------------------	-----

UCB-710 – Bio rectangular cell holder



Specifications

A cell height adjustment function provides the ability to use a 100 µL micro cell. A mask for a 100 µL micro cell is standard, 50 µL can be supplied as option.

Sample Cell	Rectangular cell pathlength 10 mm
Reference Cell	Rectangular cell pathlength 10 mm
Capacity	1 sample and 1 reference cell
Temperature	Ambient
Minimum Cell Volume	50 µL

6916-J310A – Bio-Package for V-700 series

Part Number	Model	Description
6916-H110A		Bio cell holder block (sample side cell block of UCB-710) including Mask for 100uL micro cell
4880-7472A	VWKN-772	Advanced kinetics analysis program
4880-6522A	VWTP-959	Temperature gradient measurement and DNA melting analysis program
4880-6515A	VWPN-952	Protein nucleic acid quantitation program

Materials Analysis Softwares

VWQM-978

Spectrum quantitative measurement program

VWSQ-978 package provides the quantitative analysis for a maximum of ten peaks by applying the Beer-Lambert law to each selected sample peak. Simultaneous determination of multiple components of a sample is possible if the absorption peaks of each component do not overlap. Two calculation methods are available, using either the peak height or peak area of the selected absorption peaks.

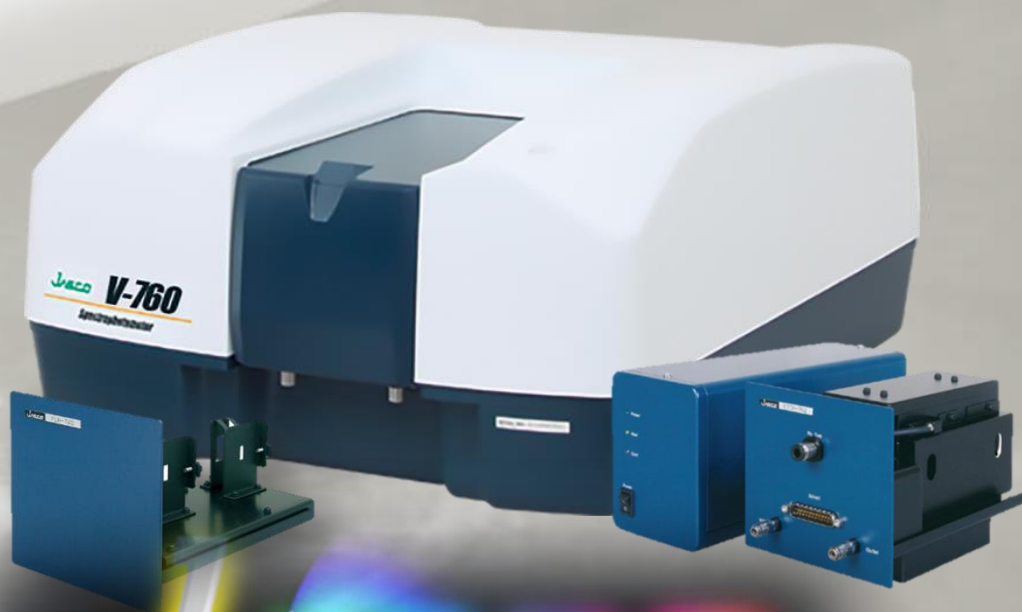

Spectra Manager Ver.2



JASCO Europe S.r.l.

Via Cadorna, 1 - 23894 Cremella (LC)

jasco@jasco-europe.com

www.jasco-europe.com

Follow us on:



DISCLAIMER

The contents of this publication are for reference and illustrative purposes only. Information, descriptions, and specifications in this document are subject to change without notice and cannot be used from third parts for data comparison and/or performance comparison. JASCO assumes no responsibility and will not be liable for any errors or omissions contained herein or for incidental, consequential damages or losses in connection with the furnishing, performance or use of this material.